

 Ply Gem®

**MASTIC®**

SIDING & ACCESSORIES

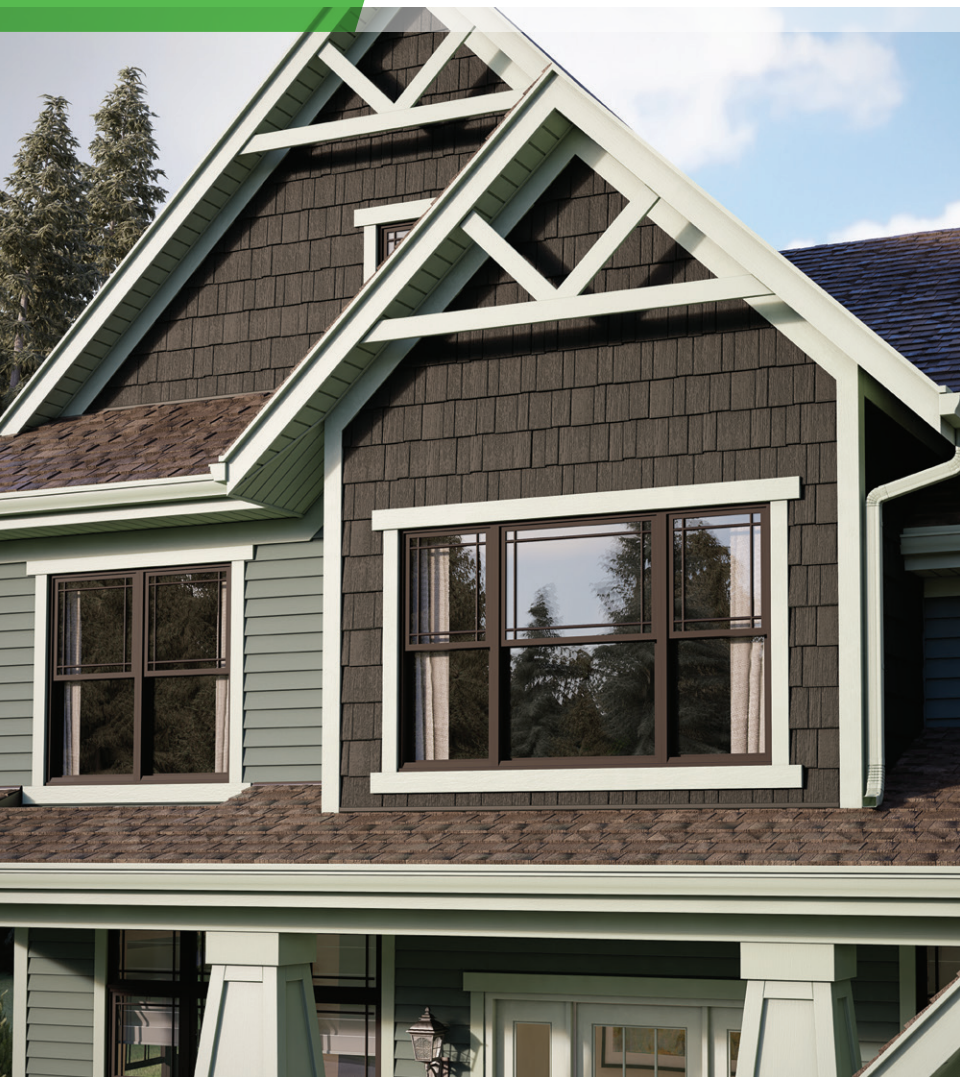

 SPECIFICATION GUIDE 2020



## BECOME A MASTIC PREFERRED OR ELITE CONTRACTOR

ONCE QUALIFIED, YOU'LL RECEIVE:

- Priority listing on Ply Gem's "Find a Pro" online directory
- Lead generation from national and regional campaigns
- Free and discounted marketing and design tools
- The ability to offer double warranties on certain product lines
- Continuing education opportunities

**TO GET STARTED VISIT [MASTIC.COM](https://www.mastic.com)**



# Table of Contents

---

## Vinyl Products

<i>Vinyl and Polypropelene Siding</i>	
Cedar Discovery®	4
Structure® Home Insulation System™	9
Quest®	15
Carvedwood•44®	18
T-Lok Barkwood®	20
Liberty Elite®	22
Western Extreme®	23
Charleston Beaded®	24
Board+Batten Designer Series™	25
Ovation™	26
Mill Creek®	28
Eclipse™	31

<i>Vinyl Siding Accessories</i>	
Universal Vinyl Siding Accessories	32

<i>Vinyl Soffit and Accessories</i>	
Ventura® Hidden Vent Soffit	41
Pro-Bead® Vinyl Soffit/Wainscot and Accessories	42
Pro-Select® Vinyl Soffit	43
Pro-Tech® Plus Vinyl Soffit	44
Universal Vinyl Soffit	46
Vinyl Soffit Accessories	48

## Designer Accents™

Shutters	51
Door Surround Systems	61
Mantel Systems	63
Window Mantels	65
Mounting Blocks	66
E-Z Block™ Surface Mounts	73
Utility Vents	75
Gable Vents	79
Designer Accents Color Matrix	84

# Table of Contents

---

## Performance Metals®

### *Trim Sheet and Trim Coil*

Trim Sheet Mastic Colors . . . . .	101
Trim Sheet CertainTeed Colors . . . . .	105
Trim Coil Mastic Colors . . . . .	106
Trim Coil Royal Colors . . . . .	109
Trim Coil Crane Colors . . . . .	110
Trim Coil Heartland Colors . . . . .	111
Trim Coil James Hardie Colors . . . . .	112
Trim Coil KP Colors . . . . .	113
Trim Coil Mitten Colors . . . . .	114
Trim Coil Norandex Colors . . . . .	115
Trim Coil Vytec Colors . . . . .	116
Trim Coil (.018) Mastic Colors . . . . .	117

### *Aluminum Siding and Accessories*

Envoy® Aluminum Siding . . . . .	118
Endurance® Aluminum Siding . . . . .	119
Aluminum Siding Accessories . . . . .	120

### *Aluminum Soffit and Fascia Accessories*

Envoy® Aluminum Soffit . . . . .	122
Endurance® Aluminum Soffit . . . . .	126
Economy Aluminum Soffit . . . . .	128
Aluminum Fascia . . . . .	130
Aluminum Soffit and Fascia Accessories . . . . .	135
Roof and Eave Ventilation Products . . . . .	139

### *Gutter Coil and Accessories*

Gutter Coil . . . . .	140
Downspout Coil . . . . .	141
Gutter and Downspout Accessories . . . . .	142

### *Sectional Gutter and Downspouts*

Metal Accessories Program for Fiber Cement . . . . .	153
7" Rainware Program . . . . .	154
Round Downspout Program . . . . .	155

# Table of Contents

---

Envoy® 5" Aluminum Gutter and Accessories . . . . .	156
Envoy® 6" Aluminum Gutter and Accessories . . . . .	159
Envoy® Aluminum Downspouts and Accessories . .	161
 <i>Gutter Protection Systems</i>	
Leaf Relief® . . . . .	163
Leaf Logic™ & Leaf Smart™ . . . . .	170
 <i>Roofing Accessories</i>	
T-Drip . . . . .	171
F-Drip . . . . .	172
C-Drip . . . . .	173
Square Drip / Gutter Apron . . . . .	174
Quick Drip / Gravel Stop . . . . .	175
Flat Flashing Squares . . . . .	176
Prebent Flashing Squares . . . . .	177
W-Valley . . . . .	178
Roll Valley . . . . .	179
 <b>Steel Siding and Accessories . . . . .</b>	 180
 <b>Specifications and Conformance . . . . .</b>	 187
 <b>Index . . . . .</b>	 193

# Cedar Discovery®

## Product Code/Description

CD70P2

### Cedar Discovery Perfection Shingle Double 7"

Nominal .080" Thick  
Panel Length: 67-3/4"  
Exposed Length: 64"  
8 Pcs./Ctn.  
1/2 Sq./Ctn.  
34 Lbs./Ctn.

Note: 3/4" minimum vinyl siding  
accessories are required for installation.

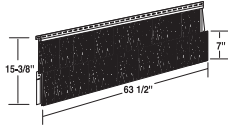

CD50P2

### Cedar Discovery Perfection Shingle Triple 5"

Nominal .090" Thick  
Panel Length: 69-1/2"  
Exposed Length: 63"  
7 Pcs./Ctn.  
.46 Sq./Ctn.  
35 Lbs./Ctn.

Note: 3/4" minimum vinyl siding  
accessories are required for installation.

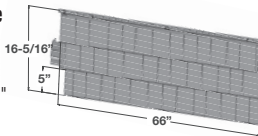

CD65HR

### Cedar Discovery Half-Round

Nominal .080" Thick  
Panel Length: 51-1/2"  
Exposed Length: 48"  
12 Pcs./Ctn.  
1/2 Sq./Ctn.  
39 Lbs./Ctn.

Note: 3/4" minimum vinyl siding  
accessories are required for installation.

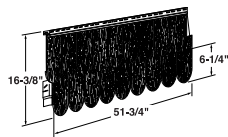

## Color Availability

White	Portsmouth Blue
Almond	Quiet Willow
Alpine Forest	Red Brick
Autumn Harvest	Rock Harbor
Brandy Wood	Rugged Canyon
Cameo	Russet Red
Classic Cream	Sage
Colonial Yellow	Sandtone
Corn Silk	Scottish Thistle
Deep Cavern	Silver Grey
Deep Granite	Terra Cotta
Desert Sand	Tuscan Olive
English Wedgewood	Victorian Grey
Everest	Vineyard Grove
Harbor Grey	Whispering Timber
Lakeshore Fern	Wicker
Linen	Woodland Retreat
Mahogany	<b>Cedar Colors</b>
Misty Shadow	Cape Grey
Montana Suede	Cedar
Natural Slate	Red Cedar
Newport Bay	Timber
Pebblestone Clay	Walnut

White	Portsmouth Blue
Almond	Quiet Willow
Alpine Forest	Red Brick
Autumn Harvest	Rock Harbor
Brandy Wood	Rugged Canyon
Cameo	Russet Red
Classic Cream	Sage
Colonial Yellow	Sandtone
Corn Silk	Scottish Thistle
Deep Cavern	Silver Grey
Deep Granite	Tuscan Olive
Desert Sand	Victorian Grey
English Wedgewood	Vineyard Grove
Everest	Whispering Timber
Harbor Grey	Wicker
Lakeshore Fern	Woodland Retreat
Linen	<b>Cedar Colors</b>
Mahogany	Cape Grey
Misty Shadow	Cedar
Montana Suede	Red Cedar
Natural Slate	
Newport Bay	
Pebblestone Clay	

White	Portsmouth Blue
Almond	Quiet Willow
Cameo	Rugged Canyon
Classic Cream	Russet Red
Colonial Yellow	Sage
Deep Granite	Sandtone
Desert Sand	Scottish Thistle
English Wedgewood	Silver Grey
Everest	Tuscan Olive
Harbor Grey	Victorian Grey
Lakeshore Fern	Wicker
Linen	
Montana Suede	
Pebblestone Clay	

## Note:

We recommend using solid color accessories to coordinate with cedar colors.

Good options include the following, however actual samples should be used for final selection:

Cedar – Montana Suede; Pebblestone Clay; Rugged Canyon; Timber – Montana Suede, Red Cedar – Terra Cotta, Autumn Harvest; Cape Grey – Harbor Grey, Deep Granite; Walnut – Montana Suede, Autumn Harvest

# Cedar Discovery®

## Product Code/Description

CD95HS

### Cedar Discovery Hand-Split Shake

Panel Length: 67-3/4"

Exposed Length: 64"

6 Pcs./Ctn.

1/2 Sq./Ctn.

41 Lbs./Ctn.

*Note: 7/8" minimum vinyl siding  
accessories are required for installation.*

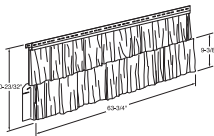

## Color Availability

White	Portsmouth Blue
Almond	Quiet Willow
Alpine Forest	Red Brick
Autumn Harvest	Rock Harbor
Brandy Wood	Rugged Canyon
Cameo	Russet Red
Classic Cream	Sage
Colonial Yellow	Sandtone
Corn Silk	Scottish Thistle
Deep Cavern	Silver Grey
Deep Granite	Terra Cotta
Desert Sand	Tuscan Olive
English Wedgewood	Victorian Grey
Everest	Vineyard Grove
Harbor Grey	Whispering Timber
Lakeshore Fern	Wicker
Linen	Woodland Retreat
Mahogany	<b>Cedar Colors</b>
Misty Shadow	Cape Grey
Montana Suede	Cedar
Natural Slate	Red Cedar
Newport Bay	Timber
Pebblestone Clay	Walnut

CD700CP2

### Cedar Discovery Perfection Corner Post - Double 7"

Nominal .080" Thick

Length: 29-1/8"

10 Pcs./Ctn.

12.30 Lbs./Ctn.



White	Portsmouth Blue
Almond	Quiet Willow
Alpine Forest	Red Brick
Autumn Harvest	Rock Harbor
Brandy Wood	Rugged Canyon
Cameo	Russet Red
Classic Cream	Sage
Colonial Yellow	Sandtone
Corn Silk	Scottish Thistle
Deep Cavern	Silver Grey
Deep Granite	Terra Cotta
Desert Sand	Tuscan Olive
English Wedgewood	Victorian Grey
Everest	Vineyard Grove
Harbor Grey	Whispering Timber
Lakeshore Fern	Wicker
Linen	Woodland Retreat
Mahogany	<b>Cedar Colors</b>
Misty Shadow	Cape Grey
Montana Suede	Cedar
Natural Slate	Red Cedar
Newport Bay	Timber
Pebblestone Clay	Walnut

CDP500CP

### Cedar Discovery Perfection Corner Post - Triple 5"

Nominal .080" Thick

Length: 31"

10 Pcs./Ctn.

19.50 Lbs./Ctn.



White	Portsmouth Blue
Almond	Quiet Willow
Alpine Forest	Red Brick
Autumn Harvest	Rock Harbor
Brandy Wood	Rugged Canyon
Cameo	Russet Red
Classic Cream	Sage
Colonial Yellow	Sandtone
Corn Silk	Scottish Thistle
Deep Cavern	Silver Grey
Deep Granite	Terra Cotta
Desert Sand	Tuscan Olive
English Wedgewood	Victorian Grey
Everest	Vineyard Grove
Harbor Grey	Whispering Timber
Lakeshore Fern	Wicker
Linen	Woodland Retreat
Mahogany	<b>Cedar Colors</b>
Misty Shadow	Cape Grey
Montana Suede	Cedar
Natural Slate	Red Cedar
Newport Bay	
Pebblestone Clay	

# Cedar Discovery®

## Product Code/Description

CDHSOCP

### Cedar Discovery Hand-Split Shake Corner Post

Nominal .080" Thick  
Length: 38"  
10 Pcs./Ctn.  
13 Lbs./Ctn.



## Color Availability

White	Portsmouth Blue
Almond	Quiet Willow
Alpine Forest	Red Brick
Autumn Harvest	Rock Harbor
Brandy Wood	Rugged Canyon
Cameo	Russet Red
Classic Cream	Sage
Colonial Yellow	Sandtone
Corn Silk	Scottish Thistle
Deep Cavern	Silver Grey
Deep Granite	Tuscan Olive
Desert Sand	Victorian Grey
English	Vineyard Grove
Wedgewood	Whispering Timber
Everest	Wicker
Harbor Grey	Woodland Retreat
Lakeshore Fern	
Linen	<b>Cedar Colors</b>
Mahogany	Cape Grey
Misty Shadow	Cedar
Montana Suede	Red Cedar
Natural Slate	Timber
Newport Bay	Walnut
Pebblestone Clay	

CDSS

### Cedar Discovery Starter Strip-Aluminum

Length: 10'  
50 Pcs./Ctn.  
33 Lbs./Ctn.

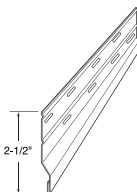

CPSSHD

### Cedar Discovery Starter Strip-Galvanized

Length: 10'  
25 Pcs./Ctn.  
49 Lbs./Ctn.

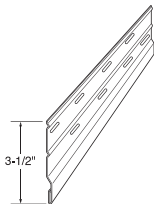

CDMFT

### Cedar Finish Trim

Length: 12'6"  
24 Pcs./Ctn.  
25 Lbs./Ctn.

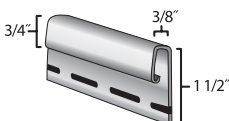

White

#### Light Colors

Almond  
Cameo  
Classic Cream  
Colonial Yellow  
Desert Sand  
Linen  
Sage  
Sandtone  
Silver Grey  
Tuscan Olive  
Victorian Grey  
Wicker

#### Classic Colors

Everest  
Harbor Grey  
Pebblestone Clay  
Scottish Thistle

#### Deep Colors

Deep Granite  
English Wedgewood  
Lakeshore Fern  
Montana Suede  
Portsmouth Blue  
Quiet Willow  
Rugged Canyon  
Russet Red  
Terra Cotta

# Cedar Discovery®

---

## Product Code/Description

---

SCMNT126  
**Snap-In Crown Mount**

Length: 12' 6"  
40 Pcs./Ctn.  
46 Lbs./Ctn.

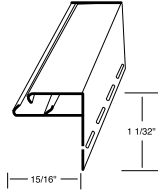

---

## Color Availability

---

White

---

JSCMNT126  
**Snap-In Crown Mount with J-Channel**

Length: 12' 6"  
40 Pcs./Ctn.  
58 Lbs./Ctn.

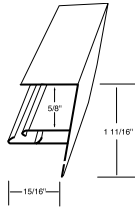

White

---

SCROWN126  
**Snap-In 3" Crown**

Length: 12' 6"  
20 Pcs./Ctn.  
55 Lbs./Ctn.

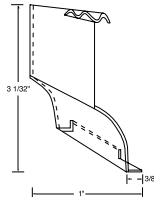

White

---

### Light Colors

Cameo  
Desert Sand  
Wicker

---

### Classic Color

Pebblestone Clay

---

Notes:

---

Notes:

# Structure

## Home Insulation System™

---

### Product Code/Description

---

SRD61EPS

**Structure  
Double 6"**

Nominal 1 1/4" Thick  
Length: 12' 6"  
8 Pcs./Ctn.  
1 Sq./Ctn.  
62 Lbs./Ctn.  
Foam: EPS

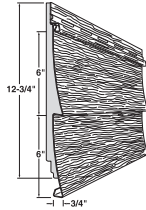

---

### Color Availability

---

White

**Light Colors**

Almond  
Cameo  
Classic Cream  
Desert Sand  
Linen  
Sage  
Sandtone  
Silver Grey  
Victorian Grey  
Wicker

**Classic Colors**

Corn Silk  
Everest

Harbor Grey  
Pebblestone Clay  
Scottish Thistle

**Deep Colors**

Autumn Harvest  
Deep Granite  
English Wedgewood  
Misty Shadow  
Montana Suede  
Quiet Willow  
Rugged Canyon  
Russet Red  
Vineyard Grove

SRS71EPS

**Structure  
Single 7"**

Nominal 1 1/4" Thick  
Length: 12' 3"  
14 Pcs./Ctn.  
1 Sq./Ctn.  
68 Lbs./Ctn.  
Foam: EPS

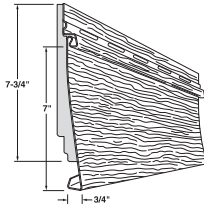

White

**Light Colors**

Almond  
Cameo  
Classic Cream  
Desert Sand  
Linen  
Sage  
Sandtone  
Silver Grey  
Victorian Grey  
Wicker

**Classic Colors**

Everest  
Harbor Grey  
Pebblestone Clay  
Scottish Thistle

**Deep Colors**

English Wedgewood  
Montana Suede  
Quiet Willow  
Rugged Canyon

Notes:

# Structure

## Home Insulation System™

---

### Product Code/Description

---

SRD41EPS

#### Structure Double 4"

Nominal 1 1/4" Thick  
Length: 12' 6"  
12 Pcs./Ctn.  
1 Sq./Ctn.  
64 Lbs./Ctn.  
Foam: EPS

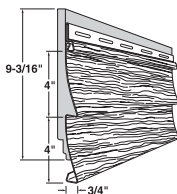

---

### Color Availability

---

White

#### Light Colors

Almond  
Cameo  
Classic Cream  
Desert Sand  
Linen  
Sage  
Sandtone  
Silver Grey  
Victorian Grey  
Wicker

#### Classic Colors

Everest  
Harbor Grey  
Pebblestone Clay  
Scottish Thistle

SRD451EPS

#### Structure Double 4-1/2" Dutch Lap

Nominal 1 1/4" Thick  
Length: 12' 1"  
11 Pcs./Ctn.  
1 Sq./Ctn.  
65 Lbs./Ctn.  
Foam: EPS

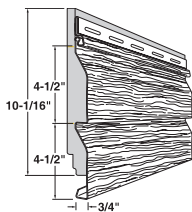

White

#### Light Colors

Almond  
Cameo  
Classic Cream  
Desert Sand  
Linen  
Sage  
Sandtone  
Silver Grey  
Victorian Grey  
Wicker

#### Classic Colors

Everest  
Harbor Grey  
Pebblestone Clay  
Scottish Thistle

#### Deep Colors

English Wedgewood  
Montana Suede  
Quiet Willow  
Rugged Canyon

---

Notes:

# Structure

## Home Insulation System™

---

### Product Code/Description

---

SRD61EPSLS

**Long Length  
Structure  
Double 6"**

Nominal 1 1/4" Thick  
Length: 16' 8"  
6 Pcs./Ctn.  
1 Sq./Ctn.  
66 Lbs./Ctn.  
Foam: EPS

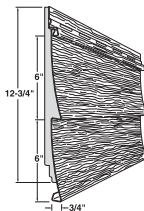

---

### Color Availability

---

White

**Light Colors**

Cameo  
Classic Cream  
Desert Sand  
Sage  
Sandtone  
Victorian Grey  
Wicker

**Classic Colors**

Corn Silk  
Everest

Harbor Grey  
Pebblestone Clay  
Scottish Thistle

**Deep Colors**

Autumn Harvest  
Deep Granite  
Misty Shadow  
Montana Suede  
Quiet Willow  
Rugged Canyon  
Russet Red  
Vineyard Grove

SRS71EPSLS

**Long Length  
Structure  
Single 7"**

Length: 16' 8"  
10 Pcs./Ctn.  
.97 Sq./Ctn.  
70 Lbs./Ctn.  
Foam: EPS

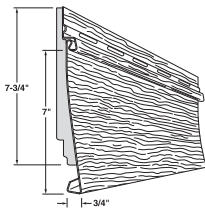

White

**Light Colors**

Cameo  
Classic Cream  
Desert Sand  
Sage  
Sandtone  
Victorian Grey  
Wicker

**Classic Colors**

Everest  
Harbor Grey  
Pebblestone Clay  
Scottish Thistle

**Deep Colors**

Montana Suede  
Quiet Willow  
Rugged Canyon

SRD451EPSLS

**Long Length  
Structure  
Double 4 1/2" Dutchlap**

Length: 16' 8"  
8 Pcs./Ctn.  
1 Sq./Ctn.  
69 Lbs./Ctn.  
Foam: EPS

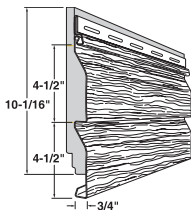

White

**Light Colors**

Cameo  
Classic Cream  
Desert Sand  
Sage  
Sandtone  
Victorian Gray  
Wicker

**Classic Colors**

Everest  
Harbor Gray  
Pebblestone Clay  
Scottish Thistle

---

Notes:

# Structure

## Home Insulation System™ Accessories

### Product Code/Description

SRLIN5

#### Structure 5" Corner Lineal with EPS Foam

Length: 20'  
10 Pcs./Ctn.  
80 Lbs./Ctn.

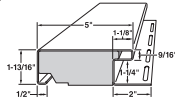

SRLIN35

#### Structure 3-1/2" Window and Door Casing Lineal with EPS Foam

Length: 20'  
10 Pcs./Ctn.  
68 Lbs./Ctn.

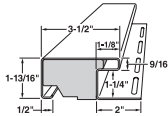

LINQRS

#### Corner Starter and Lineal

Length: 20'  
10 Pcs./Ctn.  
68 Lbs./Ctn.

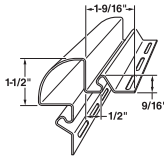

SRJSCMNT126

#### Structure Snap-In Crown Mount with J-Channel

Length: 12' 6"  
20 Pcs./Ctn.  
30 Lbs./Ctn.

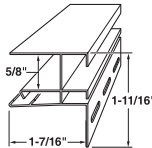

SCROWN126

#### Snap-In Crown 3" Crown

Length: 12' 6"  
20 Pcs./Ctn.  
55 Lbs./Ctn.

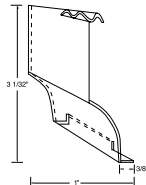

### Color Availability

White

#### Light Colors

Cameo  
Desert Sand  
Wicker

#### Classic Color

Pebblestone Clay

White

#### Light Colors

Cameo  
Desert Sand  
Wicker

#### Classic Color

Pebblestone Clay

White

#### Light Colors

Cameo  
Desert Sand  
Wicker

#### Classic Color

Pebblestone Clay

White

White

#### Light Colors

Cameo  
Desert Sand  
Wicker

#### Classic Color

Pebblestone Clay

# Structure

## Home Insulation System™ Accessories

### Product Code/Description

SRICP125

#### Structure Inside Corner Post 1-1/4"

Length: 10'  
4 Pcs./Ctn.  
7.41 Lbs./Ctn.

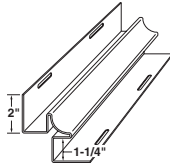

SROCP4

#### Structure 4" Corner Post with EPS Foam

Length: 12'  
4 Pcs./Ctn.  
21.7 Lbs./Ctn.

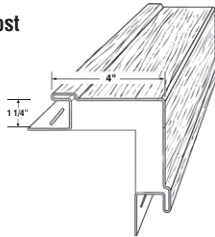

SRSS

#### Structure Starter Strip

Length: 12' 6"  
24 Pcs./Ctn.  
46 Lbs./Ctn.

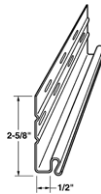

MVJ125

#### All Purpose J-Channel - 1-1/4" 1" Face

Length: 12' 6"  
20 Pcs./Ctn.  
29.5 Lbs./Ctn.

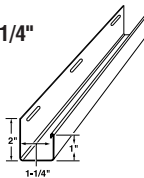

WCT12

#### 2-1/2" Wide Window Casing Trim - 1-1/4"

Length: 12' 6"  
20 Pcs./Ctn.  
66 Lbs./Ctn.

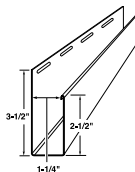

### Color Availability

White

#### Light Colors

Almond  
Cameo  
Classic Cream  
Desert Sand  
Linen  
Sage  
Sandtone  
Silver Grey  
Victorian Grey  
Wicker

#### Classic Colors

Corn Silk

Everest  
Harbor Grey  
Pebblestone Clay  
Scottish Thistle

#### Deep Colors

Autumn Harvest  
Deep Granite  
English Wedgewood  
Misty Shadow  
Montana Suede  
Quiet Willow  
Rugged Canyon  
Russet Red  
Vineyard Grove

White

#### Light Colors

Almond  
Cameo  
Classic Cream  
Desert Sand  
Linen  
Sage  
Sandtone  
Silver Grey  
Victorian Grey  
Wicker

#### Classic Colors

Corn Silk

Everest  
Harbor Grey  
Pebblestone Clay  
Scottish Thistle

#### Deep Colors

Autumn Harvest  
Deep Granite  
English Wedgewood  
Misty Shadow  
Montana Suede  
Quiet Willow  
Rugged Canyon  
Russet Red  
Vineyard Grove

White

#### Light Colors

Almond  
Cameo  
Classic Cream  
Desert Sand  
Linen  
Sage  
Sandtone  
Silver Grey  
Victorian Grey  
Wicker

#### Classic Colors

Corn Silk  
Everest

Harbor Grey  
Pebblestone Clay  
Scottish Thistle

#### Deep Colors

Autumn Harvest  
Deep Granite  
English Wedgewood  
Misty Shadow  
Montana Suede  
Quiet Willow  
Rugged Canyon  
Russet Red  
Vineyard Grove

White

# Structure

## Home Insulation System™ Accessories

---

Product Code/Description

---

MVFJ061

**Flexible J-Channel - 1-1/4"**

Length: 12' 6"

20 Pcs./Ctn.

66 Lbs./Ctn.

Throat width: 1-1/4"

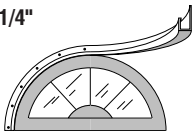

*Note: For use with Structure Home Insulation System™.*

---

Color Availability

---

White

---

Notes:

Product Code/Description

QT40

**Quest  
Double 4"**

Nominal .046" Thick  
Length: 12' 6"  
24 Pcs./Ctn.  
2 Sqs./Ctn.  
120 Lbs./Ctn.

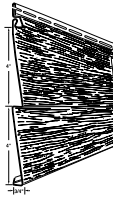

Color Availability

White

**Light Colors**

Almond  
Cameo  
Classic Cream  
Colonial Yellow  
Desert Sand  
Linen  
Sage  
Sandtone  
Silver Grey  
Tuscan Olive  
Victorian Grey  
Wicker

**Deep Colors**

Autumn Harvest  
Deep Granite  
English Wedgewood  
Lakeshore Fern  
Misty Shadow  
Montana Suede  
Portsmouth Blue  
Quiet Willow  
Rugged Canyon  
Russet Red  
Vineyard Grove

**Classic Colors**

Corn Silk  
Everest  
Harbor Grey  
Pebblestone Clay  
Scottish Thistle

**Cedar Colors**

American Walnut  
Cape Cod Grey  
Glacier Blue  
Natural Cedar  
Timberstone  
Woodland Green

QT50

**Quest  
Double 5"**

Nominal .046" Thick  
Length: 12'  
20 Pcs./Ctn.  
2 Sqs./Ctn.  
111 Lbs./Ctn.

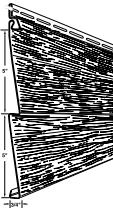

White

**Light Colors**

Almond  
Cameo  
Classic Cream  
Colonial Yellow  
Desert Sand  
Linen  
Sage  
Sandtone  
Silver Grey  
Tuscan Olive  
Victorian Grey  
Wicker

**Classic Colors**

Corn Silk  
Everest  
Harbor Grey  
Pebblestone Clay  
Scottish Thistle

**Deep Colors**

Deep Granite  
English Wedgewood  
Quiet Willow  
Rugged Canyon

QTD45

**Quest  
Double 4-1/2"  
Dutch Lap**

Nominal .046" Thick  
Length: 12' 1"  
22 Pcs./Ctn.  
2 Sqs./Ctn.  
116 Lbs./Ctn.

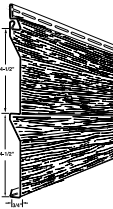

White

**Light Colors**

Almond  
Cameo  
Classic Cream  
Colonial Yellow  
Desert Sand  
Linen  
Sage  
Sandtone  
Silver Grey  
Tuscan Olive  
Victorian Grey  
Wicker

**Deep Colors**

Autumn Harvest  
Deep Granite  
English Wedgewood  
Lakeshore Fern  
Misty Shadow  
Montana Suede  
Portsmouth Blue  
Quiet Willow  
Rugged Canyon  
Russet Red  
Vineyard Grove

**Classic Colors**

Corn Silk  
Everest  
Harbor Grey  
Pebblestone Clay  
Scottish Thistle

**Cedar Colors**

American Walnut  
Cape Cod Grey  
Glacier Blue  
Natural Cedar  
Timberstone  
Woodland Green

# Quest®

Product Code/Description

QT40LS  
**Long Length**  
**Quest**  
**Double 4"**

Nominal .046" Thick  
 Length: 16' 8"  
 18 Pcs./Ctn.  
 2.04 Sqs./Ctn.  
 120 Lbs./Ctn.

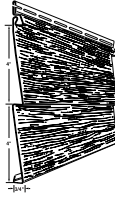

Color Availability

White

**Light Colors**

- Almond
- Cameo
- Classic Cream
- Desert Sand
- Linen
- Sage
- Sandtone
- Silver Grey
- Tuscan Olive
- Victorian Grey
- Wicker

**Classic Colors**

- Corn Silk
- Everest
- Harbor Grey
- Pebblestone Clay
- Scottish Thistle

**Deep Colors**

- Autumn Harvest
- Deep Granite
- English Wedgewood
- Misty Shadow
- Montana Suede
- Quiet Willow
- Rugged Canyon
- Vineyard Grove

QTD45LS  
**Long Length**  
**Quest**  
**Double 4-1/2" Dutch Lap**

Nominal .046" Thick  
 Length: 16' 8"  
 16 Pcs./Ctn.  
 2.10 Sqs./Ctn.  
 116 Lbs./Ctn.

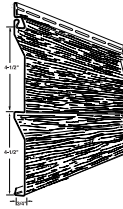

White

**Light Colors**

- Almond
- Cameo
- Classic Cream
- Desert Sand
- Linen
- Sage
- Sandtone
- Silver Grey
- Tuscan Olive
- Victorian Grey
- Wicker

**Classic Colors**

- Corn Silk
- Everest
- Harbor Grey
- Pebblestone Clay
- Scottish Thistle

**Deep Colors**

- Autumn Harvest
- Deep Granite
- English Wedgewood
- Misty Shadow
- Montana Suede
- Quiet Willow
- Rugged Canyon
- Vineyard Grove

Notes:

Product Code/Description

QT40LS255

**Super Long Length  
Quest  
Double 4"**

Nominal .046" Thick  
Length: 25' 6"  
12 Pcs./Ctn.  
2.04 Sqs./Ctn.  
116 Lbs./Ctn.

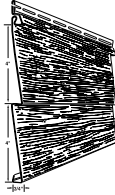

Color Availability

White

**Light Colors**

Almond  
Cameo  
Classic Cream  
Desert Sand  
Linen  
Sage  
Sandtone  
Silver Grey  
Tuscan Olive  
Victorian Grey  
Wicker

**Classic Colors**

Corn Silk  
Everest  
Harbor Grey  
Pebblestone Clay  
Scottish Thistle

**Deep Colors**

Autumn Harvest  
Deep Granite  
English Wedgewood  
Misty Shadow  
Montana Suede  
Quiet Willow  
Rugged Canyon  
Vineyard Grove

QTD45LS255

**Super Long Length  
Quest  
Double 4-1/2" Dutch Lap**

Nominal .046" Thick  
Length: 25' 6"  
11 Pcs./Ctn.  
2.10 Sqs./Ctn.  
116 Lbs./Ctn.

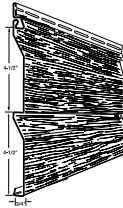

White

**Light Colors**

Almond  
Cameo  
Classic Cream  
Desert Sand  
Linen  
Sage  
Sandtone  
Silver Grey  
Tuscan Olive  
Victorian Grey  
Wicker

**Classic Colors**

Corn Silk  
Everest  
Harbor Grey  
Pebblestone Clay  
Scottish Thistle

**Deep Colors**

Autumn Harvest  
Deep Granite  
English Wedgewood  
Misty Shadow  
Montana Suede  
Quiet Willow  
Rugged Canyon  
Vineyard Grove

**Long Length Logistics Requirements**

Quest 25'6" lengths are in-stock and can be ordered with normal Mastic lead times.

Shipping requirements are:

- A minimum of 1 full crated pallet per profile can be ordered as long as the half or full truck requirement is met
- If only 1, 2, or 3 crated pallets of 25'6" material is ordered, customer must fill the balance of the half truck with standard and/or 16'8" length vinyl products (Note: 4 crated pallets of Quest 25' equal a half truck)
- If only 5, 6, or 7 crated pallets of 25'6" material is ordered, customer must fill the balance of the full truck with standard and/or 16'8" length vinyl products (Note: 8 crated pallets of Quest 25' equal a half truck)
- One profile per crated pallet
- Any available colors can be mixed within a crated pallet

# Carvedwood•44®

## Product Code/Description

CW240

### Carvedwood•44 Double 4"

Nominal .044" Thick  
Finish: Woodgrain  
Length: 12' 6"  
24 Pcs./Ctn.  
2 Sqs./Ctn.  
109 Lbs./Ctn.

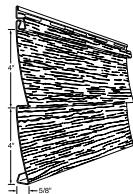

CW250

### Carvedwood•44 Double 5"

Nominal .044" Thick  
Finish: Woodgrain  
Length: 12'  
20 Pcs./Ctn.  
2 Sqs./Ctn.  
101 Lbs./Ctn.

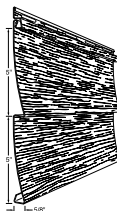

CW2D45

### Carvedwood•44 Double 4-1/2" Dutch Lap

Nominal .044" Thick  
Finish: Woodgrain  
Length: 12' 1"  
22 Pcs./Ctn.  
2 Sqs./Ctn.  
105 Lbs./Ctn.

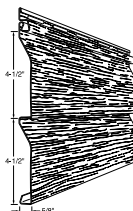

## Color Availability

White

### Light Colors

Almond  
Cameo  
Classic Cream  
Colonial Yellow  
Desert Sand  
Linen  
Sage  
Sandtone  
Silver Grey  
Tuscan Olive  
Victorian Grey  
Wicker

### Classic Colors

Corn Silk  
Everest  
Harbor Grey  
Pebblestone Clay  
Scottish Thistle

### Deep Colors

Autumn Harvest  
Brunswick  
Civic Brownstone

Deep Granite  
English Wedgewood  
Misty Shadow  
Modern Iron  
Montana Suede  
Quiet Willow  
Rugged Canyon  
Russet Red  
Vintage Dublin

### SolarDefense Reflective Technology™

Alpine Forest  
Brandy Wood  
Deep Cavern  
Mahogany  
Natural Slate  
Newport Bay  
Red Brick  
Rock Harbor  
Whispering Timber  
Woodland Retreat

White

### Light Colors

Almond  
Cameo  
Classic Cream  
Colonial Yellow  
Desert Sand  
Linen  
Sage  
Sandtone  
Silver Grey  
Tuscan Olive  
Victorian Grey  
Wicker

### Classic Colors

Corn Silk  
Everest  
Harbor Grey  
Pebblestone Clay  
Scottish Thistle

### Deep Colors

Deep Granite  
English Wedgewood  
Quiet Willow  
Rugged Canyon

White

### Light Colors

Almond  
Cameo  
Classic Cream  
Colonial Yellow  
Desert Sand  
Linen  
Sage  
Sandtone  
Silver Grey  
Tuscan Olive  
Victorian Grey  
Wicker

### Classic Colors

Corn Silk  
Everest  
Harbor Grey  
Pebblestone Clay  
Scottish Thistle

### Deep Colors

Autumn Harvest  
Brunswick  
Civic Brownstone

Deep Granite  
English Wedgewood  
Misty Shadow  
Modern Iron  
Montana Suede  
Quiet Willow  
Rugged Canyon  
Russet Red  
Vintage Dublin

### SolarDefense Reflective Technology™

Alpine Forest  
Brandy Wood  
Deep Cavern  
Mahogany  
Natural Slate  
Newport Bay  
Red Brick  
Rock Harbor  
Whispering Timber  
Woodland Retreat

# Carvedwood•44®

## Product Code/Description

CW230S  
**Carvedwood•44**  
**Triple 3"**

Nominal .044" Thick  
 Finish: Smooth  
 Length: 12' 1"  
 22 Pcs./Ctn.  
 2 Sqs./Ctn.  
 111 Lbs./Ctn.

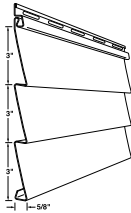

## Color Availability

White

### Light Colors

Almond  
 Cameo  
 Classic Cream  
 Colonial Yellow  
 Desert Sand  
 Linen  
 Sage  
 Sandtone  
 Silver Grey  
 Tuscan Olive  
 Victorian Grey  
 Wicker

### Classic Colors

Corn Silk  
 Everest  
 Harbor Grey  
 Pebblestone Clay  
 Scottish Thistle

### Deep Colors

Autumn Harvest  
 Deep Granite  
 English Wedgewood  
 Montana Suede  
 Quiet Willow  
 Rugged Canyon

CW240S  
**Carvedwood•44**  
**Double 4"**

Nominal .044" Thick  
 Finish: Smooth  
 Length: 12' 6"  
 24 Pcs./Ctn.  
 2 Sqs./Ctn.  
 110 Lbs./Ctn.

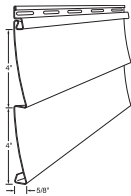

White

### Light Colors

Almond  
 Cameo  
 Classic Cream  
 Colonial Yellow  
 Desert Sand  
 Linen  
 Sage  
 Sandtone  
 Silver Grey

Tuscan Olive  
 Victorian Grey  
 Wicker

### Classic Colors

Everest  
 Harbor Grey  
 Pebblestone Clay  
 Scottish Thistle

CW80S  
**Carvedwood•44**  
**Single 8"**

Nominal .048" Thick  
 Finish: Smooth  
 Length: 12' 6"  
 24 Pcs./Ctn.  
 2 Sqs./Ctn.  
 113 Lbs./Ctn.

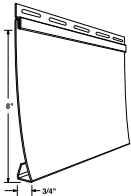

White

*\*7/8" J Channel (MVJ071) required for installation*

## Notes:

# T-lok Barkwood®

---

## Product Code/Description

---

WGV40

### T-lok Barkwood Double 4"

Nominal .048" Thick

Length: 12' 6"

24 Pcs./Ctn.

2 Sqs./Ctn.

109 Lbs./Ctn.

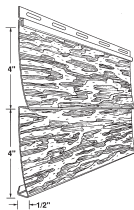

---

## Color Availability

---

White

### Light Colors

Almond  
Cameo  
Classic Cream  
Colonial Yellow  
Desert Sand  
Linen  
Sage  
Sandtone  
Silver Grey  
Victorian Grey  
Wicker

### Classic Colors

Everest  
Harbor Grey  
Pebblestone Clay  
Scottish Thistle

WGV50

### T-lok Barkwood Double 5"

Nominal .048" Thick

Length: 12'

20 Pcs./Ctn.

2 Sqs./Ctn.

105 Lbs./Ctn.

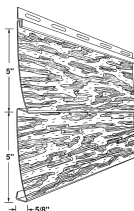

White

### Light Colors

Almond  
Cameo  
Classic Cream  
Colonial Yellow  
Desert Sand  
Linen  
Sage  
Sandtone  
Silver Grey  
Victorian Grey  
Wicker

### Classic Colors

Everest  
Harbor Grey  
Pebblestone Clay  
Scottish Thistle

---

**Notes:**

# T-lok Barkwood®

---

## Product Code/Description

---

WGV80

### T-lok Barkwood 8"

Nominal .048" Thick

Length: 12' 6"

24 Pcs./Ctn.

2 Sqs./Ctn.

108 Lbs./Ctn.

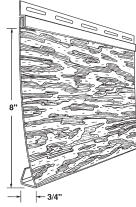

---

## Color Availability

---

White

*7/8" J Channel (MVJ071) required for installation*

---

## Notes:

# Liberty Elite®

---

## Product Code/Description

---

LD55T

### Liberty Elite Double 5" Dutch Lap

Nominal .048" Thick

Length: 12"

20 Pcs./Ctn.

2 Sqs./Ctn.

104 Lbs./Ctn.

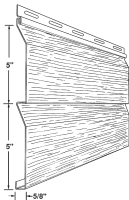

---

## Color Availability

---

White

### Light Colors

Almond  
Cameo  
Classic Cream  
Desert Sand  
Linen  
Sage  
Sandtone  
Silver Grey  
Victorian Grey  
Wicker

### Classic Colors

Everest  
Pebblestone Clay  
Scottish Thistle

---

Notes:

# Western Extreme®

## Product Code/Description

WE40

### Western Extreme Double 4"

Nominal .048" Thick  
Finish: Woodgrain  
Length: 12' 6"  
24 Pcs./Ctn.  
2 Sqs./Ctn.  
115.85 Lbs./Ctn.

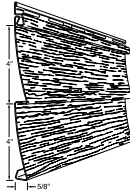

## Color Availability

White

### Light Colors

Desert Sand  
Silver Grey  
Victorian Grey  
Wicker

### Classic Colors\*

Everest  
Harbor Grey  
Pebblestone Clay  
Scottish Thistle

### Deep Colors\*

Brownstone  
Brunswick

Cinnabar  
Deep Granite  
Dublin  
English Wedgewood  
Iron  
Misty Shadow  
Montana Suede  
Quiet Willow  
Rugged Canyon

\*Classic and Deep Colors are Western Extreme HP Colors

WED40

### Double 4" Dutch Lap

Nominal .048" Thick  
Finish: Woodgrain  
Length: 12' 6"  
24 Pcs./Ctn.  
2 Sqs./Ctn.  
116.45 Lbs./Ctn.

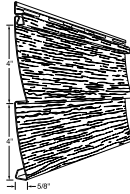

White

### Light Colors

Desert Sand  
Silver Grey  
Victorian Grey  
Wicker

### Classic Colors\*

Everest  
Harbor Grey  
Pebblestone Clay  
Scottish Thistle

### Deep Colors\*

Brownstone  
Brunswick

Cinnabar  
Deep Granite  
Dublin  
English Wedgewood  
Iron  
Misty Shadow  
Montana Suede  
Quiet Willow  
Rugged Canyon

\*Classic and Deep Colors are Western Extreme HP Colors

WEOSC4

### Western Extreme Outside Corner Post Woodgrain 4" x 3/4" x 10'

Woodgrain Finish  
Length: 10'  
10 Pcs./Ctn.  
52 Lbs./Ctn.

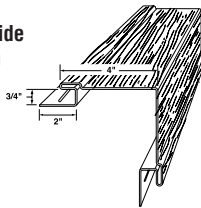

### Classic Colors\*

Everest  
Harbor Grey  
Pebblestone Clay  
Scottish Thistle

### Deep Colors\*

Brownstone  
Brunswick  
Cinnabar  
Deep Granite  
Dublin  
English Wedgewood  
Iron  
Misty Shadow  
Montana Suede  
Quiet Willow  
Rugged Canyon

\*Classic and Deep Colors are Western Extreme HP Colors

Notes:

# Charleston Beaded®

---

## Product Code/Description

---

CB65

### Charleston 6-1/2" Contemporary Beaded

Nominal .044" Thick

Finish: Brushed

Length: 12' 4"

30 Pcs./Ctn.

2 Sqs./Ctn.

115 Lbs./Ctn.

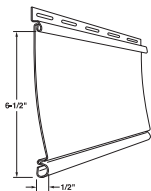

*\*Required Starter Strip: 1WAP10  
(see Aluminum Siding Accessories)*

---

## Color Availability

---

White

### Light Colors

Almond  
Cameo  
Classic Cream  
Desert Sand  
Linen  
Sage  
Sandtone  
Silver Grey  
Victorian Grey  
Wicker

### Classic Colors

Corn Silk  
Everest  
Pebblestone Clay  
Scottish Thistle

---

Notes:

# Board+Batten Designer Series™

---

## Product Code/Description

---

BB70

**Board+Batten  
Designer Series  
5-1/2" Board with  
1-1/2" Batten**

Nominal .048" Thick  
Length: 10'  
17 Pcs./Ctn.  
1 Sqs./Ctn.  
54 Lbs./Ctn.

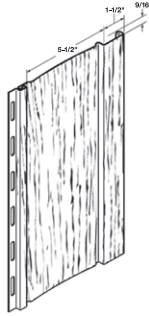

---

## Color Availability

---

White

**Light Colors**

Almond  
Classic Cream  
Desert Sand  
Sandtone  
Tuscan Olive  
Victorian Grey  
Wicker

**Classic Colors**

Corn Silk  
Everest  
Harbor Grey  
Pebblestone Clay  
Scottish Thistle

**Deep Colors**

Autumn Harvest  
Brunswick  
Civic Brownstone  
Deep Granite  
English Wedgewood  
Lakeshore Fern  
Misty Shadow  
Montana Suede  
Quiet Willow  
Rugged Canyon  
Russet Red  
Vintage Dublin

---

Notes:

# Ovation™

## Product Code/Description

Ov40  
**Ovation Double 4"**  
 Nominal .042" Thick  
 Finish: Woodgrain  
 Length: 12' 6"  
 24 Pcs./Ctn.  
 2 Sqs./Ctn.  
 92 Lbs./Ctn.

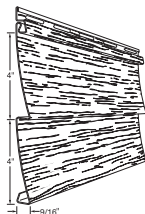

Ov50  
**Ovation Double 5"**  
 Nominal .042" Thick  
 Finish: Woodgrain  
 Length: 12'  
 20 Pcs./Ctn.  
 2 Sqs./Ctn.  
 95 Lbs./Ctn.

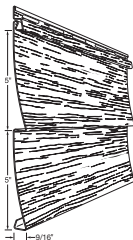

OVD45  
**Ovation Double 4.5" Dutch Lap**  
 Nominal .042" Thick  
 Finish: Woodgrain  
 Length: 12' 1"  
 22 Pcs./Ctn.  
 2 Sqs./Ctn.  
 101 Lbs./Ctn.

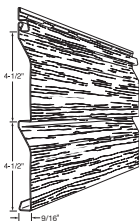

## Color Availability

White

### Light Colors

Almond  
 Cameo  
 Classic Cream  
 Desert Sand  
 Linen  
 Sage  
 Sandtone  
 Silver Grey  
 Tuscan Olive  
 Victorian Grey  
 Wicker

### Classic Colors

Corn Silk  
 Everest  
 Harbor Grey  
 Pebblestone Clay  
 Scottish Thistle

### Deep Colors

English Wedgewood  
 Deep Granite  
 Misty Shadow  
 Montana Suede  
 Quiet Willow  
 Rugged Canyon  
 Vintage Dublin

### SolarDefense Reflective Technology™

Brandy Wood  
 Mahogany  
 Natural Slate  
 Newport Bay  
 Red Brick

White

### Light Colors

Almond  
 Cameo  
 Classic Cream  
 Desert Sand  
 Linen  
 Sage  
 Sandtone  
 Silver Grey  
 Tuscan Olive  
 Victorian Grey  
 Wicker

### Classic Colors

Corn Silk  
 Everest  
 Harbor Grey  
 Pebblestone Clay  
 Scottish Thistle

### Deep Colors

English Wedgewood  
 Deep Granite  
 Quiet Willow  
 Rugged Canyon

White

### Light Colors

Almond  
 Cameo  
 Classic Cream  
 Desert Sand  
 Linen  
 Sage  
 Sandtone  
 Silver Grey  
 Tuscan Olive  
 Victorian Grey  
 Wicker

### Classic Colors

Corn Silk  
 Everest  
 Harbor Grey  
 Pebblestone Clay  
 Scottish Thistle

### Deep Colors

English Wedgewood  
 Deep Granite  
 Misty Shadow  
 Montana Suede  
 Quiet Willow  
 Rugged Canyon  
 Vintage Dublin

### SolarDefense Reflective Technology™

Brandy Wood  
 Mahogany  
 Natural Slate  
 Newport Bay  
 Red Brick

# Ovation™

---

## Product Code/Description

---

OV30S

### Ovation Triple 3"

Nominal .042" Thick

Finish: Brushed

Length: 12' 1"

22 Pcs./Ctn.

2 Sqs./Ctn.

98 Lbs./Ctn.

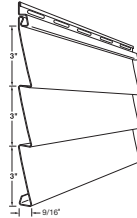

---

## Color Availability

---

White

### Light Colors

Almond  
Cameo  
Classic Cream  
Desert Sand  
Linen  
Sage  
Sandtone  
Silver Grey  
Tuscan Olive  
Victorian Grey  
Wicker

### Classic Colors

Everest  
Harbor Grey  
Pebblestone Clay  
Scottish Thistle

OVB65

### Ovation 6 1/2" Beaded

Nominal .042" Thick

Finish: Woodgrain

Length: 12' 4"

30 Pcs./Ctn.

2 Sqs./Ctn.

98 Lbs./Ctn.

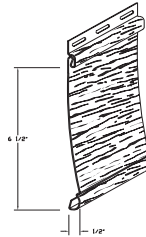

White

### Light Colors

Almond  
Cameo  
Classic Cream  
Desert Sand  
Linen  
Sage  
Sandtone  
Silver Grey  
Tuscan Olive  
Victorian Grey  
Wicker

### Classic Colors

Everest  
Harbor Grey  
Pebblestone Clay  
Scottish Thistle

---

## Notes:

*\*Requires Starter Strip: 1WAP10  
(See Aluminum Siding Accessories)*

# Mill Creek®

## Product Code/Description

MC40

### Mill Creek Double 4"

Nominal .040" Thick

Length: 12' 6"

24 Pcs./Ctn.

2 Sqs./Ctn.

90 Lbs./Ctn.

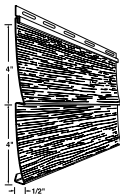

MCD40

### Mill Creek Double 4" Dutch Lap

Nominal .040" Thick

Length: 12' 6"

24 Pcs./Ctn.

2 Sqs./Ctn.

93 Lbs./Ctn.

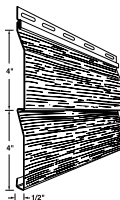

MCD45

### Mill Creek Double 4.5" Dutch Lap

Nominal .040" Thick

Length: 12' 1"

22 Pcs./Ctn.

2 Sqs./Ctn.

88 Lbs./Ctn.

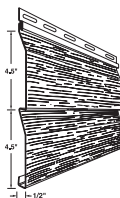

## Color Availability

White

### Light Colors

Almond  
Cameo  
Classic Cream  
Desert Sand  
Sandtone  
Silver Grey  
Tuscan Olive  
Victorian Grey  
Wicker

### Classic Colors

Everest  
Pebblestone Clay  
Scottish Thistle

White

### Light Colors

Almond  
Cameo  
Classic Cream  
Desert Sand  
Sandtone  
Silver Grey  
Tuscan Olive  
Victorian Grey  
Wicker

### Classic Colors

Everest  
Pebblestone Clay  
Scottish Thistle

White

### Light Colors

Almond  
Cameo  
Classic Cream  
Desert Sand  
Sandtone  
Silver Grey  
Tuscan Olive  
Victorian Grey  
Wicker

### Classic Colors

Everest  
Pebblestone Clay  
Scottish Thistle

Notes:

# Mill Creek®

## Product Code/Description

MC50  
**Mill Creek  
 Double 5"**

Nominal .040" Thick  
 Length: 12'  
 20 Pcs./Ctn.  
 2 Sqs./Ctn.  
 85 Lbs./Ctn.

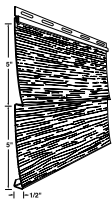

MCD50  
**Mill Creek  
 Double 5" Dutch Lap**

Nominal .040" Thick  
 Length: 12'  
 20 Pcs./Ctn.  
 2 Sqs./Ctn.  
 86 Lbs./Ctn.

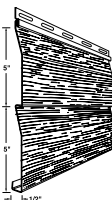

MC30  
**Mill Creek  
 Triple 3"**

Nominal .040" Thick  
 Length: 12'1"  
 22 Pcs./Ctn.  
 2 Sqs./Ctn.  
 89 Lbs./Ctn.

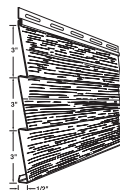

## Color Availability

White

**Light Colors**

Almond  
 Cameo  
 Classic Cream  
 Desert Sand  
 Sandtone  
 Silver Grey  
 Tuscan Olive  
 Victorian Grey  
 Wicker

**Classic Colors**

Everest  
 Pebblestone Clay  
 Scottish Thistle

White

**Light Colors**

Almond  
 Cameo  
 Classic Cream  
 Desert Sand  
 Sandtone  
 Silver Grey  
 Tuscan Olive  
 Victorian Grey  
 Wicker

**Classic Colors**

Everest  
 Pebblestone Clay  
 Scottish Thistle

White

**Light Colors**

Almond  
 Cameo  
 Classic Cream  
 Desert Sand  
 Sandtone  
 Silver Grey  
 Tuscan Olive  
 Victorian Grey  
 Wicker

**Classic Colors**

Everest  
 Pebblestone Clay  
 Scottish Thistle

Notes:

---

Notes:

# Eclipse™

## Product Code/Description

EC40

### Eclipse Double 4"

Nominal .040" Thick  
Length: 12' 6"  
24 Pcs./Ctn.  
2 Sqs./Ctn.  
86 Lbs./Ctn.

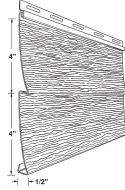

EC50

### Eclipse Double 5"

Nominal .040" Thick  
Length: 12'  
20 Pcs./Ctn.  
2 Sqs./Ctn.  
81 Lbs./Ctn.

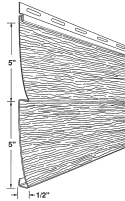

ECD45

### Eclipse Double 4-1/2" Dutch Lap

Nominal .040" Thick  
Length: 12' 1"  
22 Pcs./Ctn.  
2 Sqs./Ctn.  
83 Lbs./Ctn.

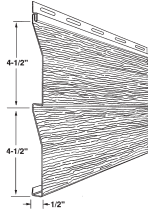

## Color Availability

White

### Light Colors

Almond  
Cameo  
Classic Cream  
Desert Sand  
Sandtone  
Silver Grey  
Tuscan Olive  
Victorian Grey  
Wicker

### Classic Colors

Everest  
Pebblestone Clay  
Scottish Thistle

White

### Light Colors

Almond  
Cameo  
Classic Cream  
Desert Sand  
Sandtone  
Silver Grey  
Tuscan Olive  
Victorian Grey  
Wicker

### Classic Colors

Everest  
Pebblestone Clay  
Scottish Thistle

White

### Light Colors

Almond  
Cameo  
Classic Cream  
Desert Sand  
Sandtone  
Silver Grey  
Tuscan Olive  
Victorian Grey  
Wicker

### Classic Colors

Everest  
Pebblestone Clay  
Scottish Thistle

\*New colors

Notes:

# Universal Vinyl Siding Accessories

---

Product Code/Description

---



---

Color Availability

---

MVS250

**Starter Strip Vinyl - 1/4"**

Length: 12' 6"  
40 Pcs./Ctn.  
69 Lbs./Ctn.

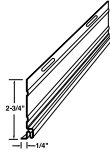

MVSR110

**Starter Strip Vinyl - 1-1/4"**

Length: 12' 6"  
24 Pcs./Ctn.  
51 Lbs./Ctn.

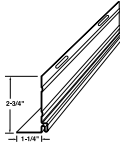

White

---

VSS10NS

**Starter Strip  
Aluminum (Spring Style)**

Length: 10'  
50 Pcs./Ctn.  
33 Lbs./Ctn.

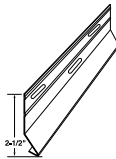

ASVSS25

**Steel Starter Strip (galvanized)**

Length: 10'  
25 Pcs./Ctn.  
40 Lbs./Ctn.

*(Not to be installed with aluminum siding)*

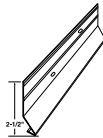

ASVSS35

**Steel Starter Strip (galvanized)**

Length: 10'  
25 Pcs./Ctn.  
49 Lbs./Ctn.

*(Not to be installed with aluminum siding)*

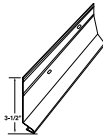

# Universal Vinyl Siding Accessories

## Product Code/Description

AWOP06

### Universal Outside Corner Post Woodgrain 4" x 3/4" x 10'

Woodgrain Finish  
Length: 10'  
10 Pcs./Ctn.  
50 Lbs./Ctn.

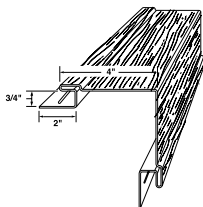

## Color Availability

White

### Light Colors

Almond  
Cameo  
Classic Cream  
Colonial Yellow  
Desert Sand  
Linen  
Sage  
Sandtone  
Silver Grey  
Tuscan Olive  
Victorian Grey  
Wicker

### Classic Colors

Corn Silk  
Everest  
Harbor Grey  
Pebblestone Clay  
Scottish Thistle

### Deep Colors

Autumn Harvest  
Deep Granite  
English Wedgewood  
Lakeshore Fern  
Misty Shadow

Montana Suede  
Portsmouth Blue  
Quiet Willow  
Rugged Canyon  
Russet Red  
Terra Cotta  
Vineyard Grove

### Cedar Colors

American Walnut  
Cape Cod Grey  
Glacier Blue  
Natural Cedar  
Timberstone  
Woodland Green

### SolarDefense

Alpine Forest  
Brandy Wood  
Deep Cavern  
Mahogany  
Natural Slate  
Newport Bay  
Red Brick  
Rock Harbor  
Whispering Timber  
Woodland Retreat

WOCP306

### Universal Outside Corner Post Woodgrain 3" x 3/4" x 10'

Woodgrain Finish  
Length: 10'  
10 Pcs./Ctn.  
37 Lbs./Ctn.

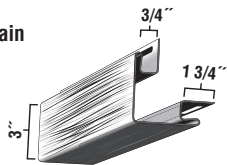

White

### Light Colors

Almond  
Cameo  
Classic Cream  
Colonial Yellow  
Desert Sand  
Linen  
Sage  
Sandtone  
Silver Grey  
Tuscan Olive  
Victorian Grey  
Wicker

### Classic Colors

Corn Silk  
Everest  
Harbor Grey  
Pebblestone Clay  
Scottish Thistle

Notes:

# Universal Vinyl Siding Accessories

## Product Code/Description

MTOP06

### Universal Outside Corner Post Matte 4" x 3/4" x 10'

Matte Finish  
Length: 10'  
10 Pcs./Ctn.  
51 Lbs./Ctn.

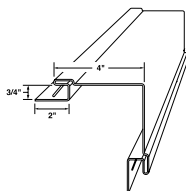

BAY0P06

### Bay Corner - 3/4"

Length: 10'  
10 Pcs./Ctn.  
33.4 lbs./CFA.

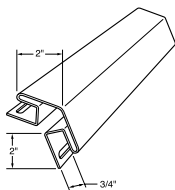

MICP06

### Inside Corner Post - 3/4"

Length: 10'  
10 Pcs./Ctn.  
24.43 Lbs./Ctn.

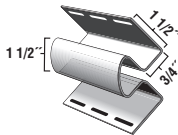

## Color Availability

White

### Light Colors

Almond  
Cameo  
Classic Cream  
Colonial Yellow  
Desert Sand  
Linen  
Sage  
Sandtone  
Silver Grey  
Tuscan Olive  
Victorian Grey  
Wicker

### Classic Colors

Everest  
Harbor Grey  
Pebblestone Clay  
Scottish Thistle

White

### Light Colors

Cameo  
Desert Sand  
Wicker

### Classic Color

Pebblestone Clay

White

### Light Colors

Almond  
Cameo  
Classic Cream  
Colonial Yellow  
Desert Sand  
Linen  
Sage  
Sandtone  
Silver Grey  
Tuscan Olive  
Victorian Grey  
Wicker

### Classic Colors

Corn Silk  
Everest  
Harbor Grey  
Pebblestone Clay  
Scottish Thistle

### Deep Colors

Autumn Harvest  
Deep Granite  
English Wedgewood  
Lakeshore Fern  
Misty Shadow

Montana Suede  
Portsmouth Blue  
Quiet Willow  
Rugged Canyon  
Russet Red  
Terra Cotta  
Vineyard Grove

### Cedar Colors

American Walnut  
Cape Cod Grey  
Glacier Blue  
Natural Cedar  
Timberstone  
Woodland Green

### SolarDefense

Alpine Forest  
Brandy Wood  
Deep Cavern  
Mahogany  
Natural Slate  
Newport Bay  
Red Brick  
Rock Harbor  
Whispering Timber  
Woodland Retreat

# Universal Vinyl Siding Accessories

---

## Product Code/Description

---

TFOP55  
**Traditional 5-1/2"  
 Outside Corner Post  
 with Foam Insert**

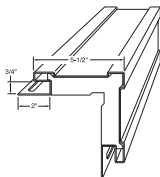

Length: 20'  
 4 Pcs./Ctn.  
 67 Lbs./Ctn.

---

## Color Availability

---

White

**Light Colors**

Cameo  
 Desert Sand  
 Wicker

**Classic Color**

Pebblestone Clay

---

FFOP55  
**Fluted 5-1/2"  
 Outside Corner  
 Post with Foam Insert**

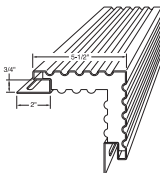

Length: 20'  
 4 Pcs./Ctn.  
 67 Lbs./Ctn.

White

---

LINQRS  
**Corner Starter and Insert**

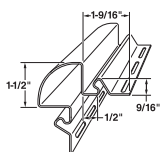

Length: 20'  
 10 Pcs./Ctn.  
 68 Lbs./Ctn.

White

**Light Colors**

Cameo  
 Desert Sand  
 Wicker

**Classic Color**

Pebblestone Clay

---

Notes:

# Universal Vinyl Siding Accessories

Product Code/Description

Color Availability

LIN5  
**5" Fluted Lineal**

Length: 20'  
 10 Pcs./Ctn.  
 78 Lbs./Ctn.

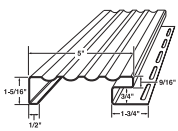

White

LIN5  
**5" Lineal**

Length: 20'  
 10 Pcs./Ctn.  
 78 Lbs./Ctn.

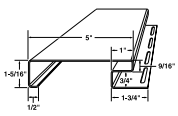

White

**Light Colors**  
 Cameo  
 Desert Sand  
 Wicker

**Classic Color**  
 Pebblestone Clay

LIN35  
**3-1/2" Lineal**

Length: 20'  
 10 Pcs./Ctn.  
 65 Lbs./Ctn.

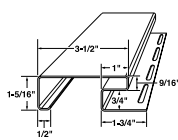

White

**Light Colors**  
 Cameo  
 Desert Sand  
 Wicker

**Classic Color**  
 Pebblestone Clay

WCNCSS  
**New Construction  
 Lineal Starter**

Length: 12' 6"  
 40 Pcs./Ctn.  
 40 Lbs./Ctn.

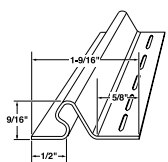

White

WCRSS  
**Remodeling  
 Lineal Starter**

Length: 12' 6"  
 40 Pcs./Ctn.  
 58 Lbs./Ctn.

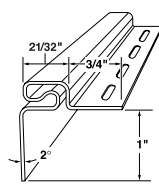

White

# Universal Vinyl Siding Accessories

## Product Code/Description

MVJ051

### All Purpose J-Channel - 5/8" 1" Face

Length: 12' 6"  
40 Pcs./Ctn.  
45 Lbs./Ctn.

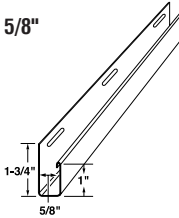

MVJ071

### All Purpose J-Channel - 7/8" 1" Face

Length: 12' 6"  
40 Pcs./Ctn.  
48 Lbs./Ctn.

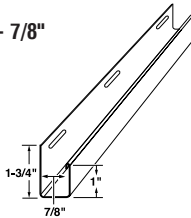

## Color Availability

White

### Light Colors

Almond  
Cameo  
Classic Cream  
Colonial Yellow  
Desert Sand  
Linen  
Sage  
Sandtone  
Silver Grey  
Tuscan Olive  
Victorian Grey  
Wicker

### Classic Colors

Corn Silk  
Everest  
Harbor Grey  
Pebblestone Clay  
Scottish Thistle

### Deep Colors

Autumn Harvest  
Deep Granite  
English Wedgewood  
Lakeshore Fern  
Misty Shadow  
Montana Suede  
Portsmouth Blue  
Quiet Willow  
Rugged Canyon

Russet Red  
Vineyard Grove

### Dark Color

\*Musket Brown

### Cedar Colors

American Walnut  
Cape Cod Grey  
Glacier Blue  
Natural Cedar  
Timberstone  
Woodland Green

### SolarDefense

Alpine Forest  
Brandy Wood  
Deep Cavern  
Mahogany  
Natural Slate  
Newport Bay  
Red Brick  
Rock Harbor  
Whispering Timber  
Woodland Retreat

### Western Extreme

Brownstone  
Brunswick  
Cinnabar  
Dublin

White

### Light Colors

Almond  
Cameo  
Classic Cream  
Colonial Yellow  
Desert Sand  
Linen  
Sage  
Sandtone  
Silver Grey  
Tuscan Olive  
Victorian Grey  
Wicker

### Classic Colors

Corn Silk  
Everest  
Harbor Grey  
Pebblestone Clay  
Scottish Thistle

### Deep Colors

Autumn Harvest  
Deep Granite  
English Wedgewood  
Lakeshore Fern  
Misty Shadow

Montana Suede  
Portsmouth Blue  
Quiet Willow  
Rugged Canyon  
Russet Red  
Terra Cotta  
Vineyard Grove

### Cedar Colors

American Walnut  
Cape Cod Grey  
Glacier Blue  
Natural Cedar  
Timberstone  
Woodland Green

### SolarDefense

Alpine Forest  
Brandy Wood  
Deep Cavern  
Mahogany  
Natural Slate  
Newport Bay  
Red Brick  
Rock Harbor  
Whispering Timber  
Woodland Retreat

\*Musket Brown color is not warranted for sidewall use.

# Universal Vinyl Siding Accessories

---

## Product Code/Description

---

MVJ125

### All Purpose J-Channel - 1-1/4" 1" Face

Length: 12' 6"  
40 Pcs./Ctn.  
53 Lbs./Ctn.

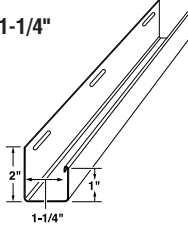

---

## Color Availability

---

White

### Light Colors

Almond  
Cameo  
Classic Cream  
Desert Sand  
Linen  
Sage  
Sandtone  
Silver Grey  
Victorian Grey  
Wicker

### Classic Colors

Corn Silk  
Everest

Harbor Grey  
Pebblestone Clay  
Scottish Thistle

### Deep Colors

Autumn Harvest  
English Wedgewood  
Deep Granite  
Misty Shadow  
Montana Suede  
Quiet Willow  
Rugged Canyon  
Russet Red  
Vineyard Grove

MVFJ0341

### Flexible J-Channel - 1"

Length: 12' 6"  
20 Pcs./Ctn.  
66 Lbs./Ctn.  
Throat width: 13/16"

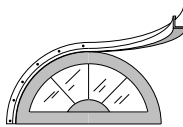

White

### Light Colors

Cameo  
Desert Sand  
Wicker

### Classic Color

Pebblestone Clay

Notes:

# Universal Vinyl Siding Accessories

Product Code/Description

Color Availability

SCMNT126  
**Snap-In Crown Mount**

Length: 12' 6"  
40 Pcs./Ctn.  
46 Lbs./Ctn.

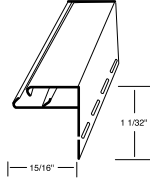

White

JSCMNT126  
**Snap-In Crown Mount  
with J-Channel**

Length: 12' 6"  
40 Pcs./Ctn.  
58 Lbs./Ctn.

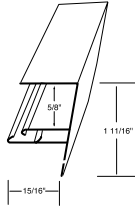

White

SCROWN126  
**Snap-In Crown 3" Crown**

Length: 12' 6"  
20 Pcs./Ctn.  
55 Lbs./Ctn.

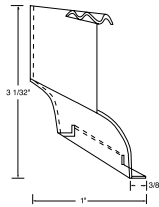

White

**Light Colors**  
Carneo  
Desert Sand  
Wicker

**Classic Color**  
Pebblestone Clay

Notes:

# Universal Vinyl Siding Accessories

## Product Code/Description

MFT  
**Finish Trim**  
Length: 12' 6"  
40 Pcs./Ctn.  
46 Lbs./Ctn.

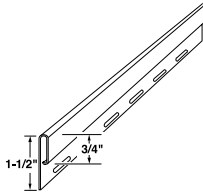

MVDFT  
**Double Finish Trim**  
Length: 12' 6"  
20 Pcs./Ctn.  
31 Lbs./Ctn.

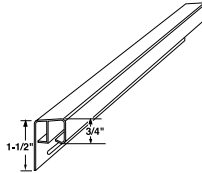

WCT06  
**2-1/2" Wide  
Window Casing Trim - 3/4"**  
Length: 12' 6"  
20 Pcs./Ctn.  
55 Lbs./Ctn.

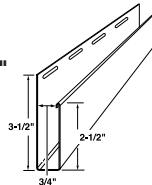

WCT12  
**2-1/2" Wide Window  
Casing Trim - 1-1/4"**  
Length: 12' 6"  
20 Pcs./Ctn.  
66 Lbs./Ctn.

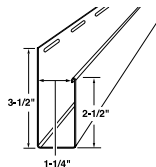

## Color Availability

White

### Light Colors

Almond  
Cameo  
Classic Cream  
Colonial Yellow  
Desert Sand  
Linen  
Sage  
Sandtone  
Silver Grey  
Tuscan Olive  
Victorian Grey  
Wicker

### Classic Colors

Corn Silk  
Everest  
Harbor Grey  
Pebblestone Clay  
Scottish Thistle

### Deep Colors

Autumn Harvest  
Deep Granite  
English Wedgewood  
Lakeshore Fern  
Misty Shadow  
Montana Suede  
Portsmouth Blue

Quiet Willow  
Rugged Canyon  
Russet Red  
Vineyard Grove

### Cedar Colors

American Walnut  
Cape Cod Grey  
Glacier Blue  
Natural Cedar  
Timberstone  
Woodland Green

### SolarDefense

Alpine Forest  
Brandy Wood  
Deep Cavern  
Mahogany  
Natural Slate  
Newport Bay  
Red Brick  
Rock Harbor  
Whispering Timber  
Woodland Retreat

### Western Extreme

Brownstone  
Brunswick  
Cinnabar  
Dublin

White

### Light Colors

Almond  
Cameo  
Classic Cream  
Desert Sand  
Linen  
Sage  
Sandtone  
Silver Grey  
Tuscan Olive  
Victorian Grey

Wicker

### Classic Colors

Everest  
Harbor Grey  
Pebblestone Clay  
Scottish Thistle

### Deep Colors

Deep Granite  
Misty Shadow  
Rugged Canyon

White

### Light Colors

Cameo  
Desert Sand  
Wicker

### Classic Color

Pebblestone Clay

White

# Ventura® Hidden Vent Soffit

## Product Code/Description

HVS10V

### Ventura® Triple 3-1/3" Hidden Vent Soffit

Nominal .044" Thick  
Finish: Matte  
9.19 Sq. In. N.F.A./Sq. Ft.  
Length: 12'  
20 Pcs./Ctn.  
2 Sqs./Ctn.  
122 Lbs./Ctn.

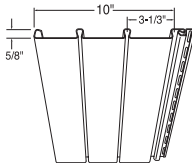

## Color Availability

White

### Light Colors

Almond  
Cameo  
Classic Cream  
Colonial Yellow  
Desert Sand  
Linen  
Sage  
Sandtone  
Silver Grey  
Tuscan Olive  
Victorian Grey  
Wicker

### Classic Colors

Corn Silk  
Everest  
Harbor Grey  
Pebblestone Clay  
Scottish Thistle

### Deep Colors

Autumn Harvest  
Deep Granite  
English Wedgewood  
Lakeshore Fern  
Misty Shadow  
Montana Suede  
Portsmouth Blue  
Quiet Willow  
Rugged Canyon  
Russet Red  
Vineyard Grove

### Dark Color

Musket Brown

HVS10N

### Ventura® Triple 3-1/3" Non-Ventilated Soffit/Wainscot

Nominal .044" Thick  
Finish: Matte  
Length: 12'  
20 Pcs./Ctn.  
2 Sqs./Ctn.  
121 Lbs./Ctn.

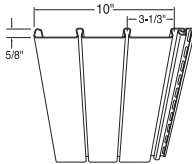

White

### Light Colors

Almond  
Cameo  
Classic Cream  
Colonial Yellow  
Desert Sand  
Linen  
Sage  
Sandtone  
Silver Grey  
Tuscan Olive  
Victorian Grey  
Wicker

### Classic Colors

Corn Silk  
Everest  
Harbor Grey  
Pebblestone Clay  
Scottish Thistle

### Deep Colors

Autumn Harvest  
Deep Granite  
English Wedgewood  
Lakeshore Fern  
Misty Shadow  
Montana Suede  
Portsmouth Blue  
Quiet Willow  
Rugged Canyon  
Russet Red  
Vineyard Grove

### Dark Color

Musket Brown

*(Musket Brown color not warranted for sidewall use.)*

Notes:

# Pro-Bead® Vinyl Soffit/ Wainscot and Accessories

---

## Product Code/Description

---

PBS80N

**Pro-Bead® 8"  
Non-Ventilated  
Soffit/Wainscot**

Nominal .040" Thick  
Finish: Matte  
Length: 12' 6"  
24 Pcs./Ctn.  
2 Sqs./Ctn.  
116 Lbs./Ctn.

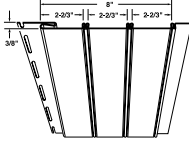

---

## Color Availability

---

White

**Light Colors**

Cameo  
Classic Cream  
Desert Sand  
Sandtone  
Victorian Grey  
Wicker

**Classic Color**

Pebblestone Clay

---

PBS80V

**Pro-Bead® 8"  
Ventilated Soffit**

Nominal .040" Thick  
Finish: Matte  
1.54 Sq. In. N.F.A./Sq. Ft.  
Length: 12' 6"  
24 Pcs./Ctn.  
2 Sqs./Ctn.  
116 Lbs./Ctn.

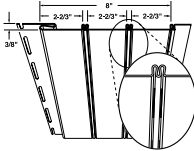

White

**Light Colors**

Cameo  
Classic Cream  
Desert Sand  
Sandtone  
Victorian Grey  
Wicker

**Classic Color**

Pebblestone Clay

---

PBSJ03

**Pro-Bead®  
J-Channel - 3/8"**

Length: 12' 6"  
24 Pcs./Ctn.  
300 Ft./Ctn.  
39 Lbs./Ctn.

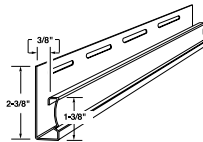

White

**Light Colors**

Cameo  
Classic Cream  
Desert Sand  
Sandtone  
Victorian Grey  
Wicker

**Classic Color**

Pebblestone Clay

---

Notes:

# Pro-Select® Vinyl Soffit

## Product Code/Description

PSS10N  
**Pro-Select®  
 Double 5" Premium  
 Non-Ventilated Panel**

Nominal .046" Thick  
 Finish: Brushed  
 Length: 12'  
 20 Pcs./Ctn.  
 2 Sqs./Ctn.  
 107 Lbs./Ctn.

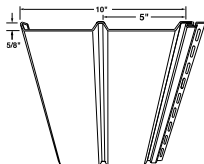

*(Montana Suede and Musket Brown colors not warranted for sidewall use.)*

## Color Availability

White

### Light Colors

Almond  
 Cameo  
 Classic Cream  
 Desert Sand  
 Linen  
 Sage  
 Sandtone  
 Silver Grey  
 Tuscan Olive  
 Victorian Grey  
 Wicker

### Dark Color

\*Musket Brown

### Deep Color

\*Montana Suede

### Cedar Colors

American Walnut  
 Cape Cod Grey  
 Glacier Blue  
 Natural Cedar  
 Timberstone  
 Woodland Green

### Classic Colors

Everest  
 Harbor Grey  
 Pebblestone Clay  
 Scottish Thistle

PSS10V  
**Pro-Select®  
 Double 5" Premium  
 Ventilated Panel**

Nominal .046" Thick  
 Finish: Brushed  
 7.53 Sq. In. N.F.A./Sq. Ft.  
 Length: 12'  
 20 Pcs./Ctn.  
 2 Sqs./Ctn.  
 104 Lbs./Ctn.

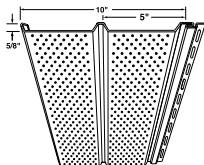

White

### Light Colors

Almond  
 Cameo  
 Classic Cream  
 Desert Sand  
 Linen  
 Sage  
 Sandtone  
 Silver Grey  
 Tuscan Olive  
 Victorian Grey  
 Wicker

### Dark Color

Musket Brown

### Deep Color

Montana Suede

### Cedar Colors

American Walnut  
 Cape Cod Grey  
 Glacier Blue  
 Natural Cedar  
 Timberstone  
 Woodland Green

### Classic Colors

Everest  
 Harbor Grey  
 Pebblestone Clay  
 Scottish Thistle

Notes:

# Pro-Tech® Plus Vinyl Soffit

## Product Code/Description

PTS12N  
**Pro-Tech® Plus  
 Triple 4"  
 Non-Ventilated Panel**

Nominal .040" Thick  
 Finish: Matte  
 Length: 12'  
 16 Pcs./Ctn.  
 1.92 Sqs./Ctn.  
 90 Lbs./Ctn.

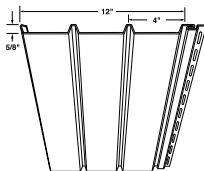

*(Musket Brown color not warranted for sidewall use.)*

## Color Availability

White

### Light Colors

Almond  
 Cameo  
 Classic Cream  
 Desert Sand  
 Linen  
 Sage  
 Sandtone  
 Silver Grey  
 Tuscan Olive  
 Victorian Grey  
 Wicker

### Classic Colors

Everest  
 Harbor Grey  
 Pebblestone Clay  
 Scottish Thistle

### Dark Color

\*Musket Brown

PTS12V  
**Pro-Tech® Plus  
 Triple 4"  
 Ventilated Panel**

Nominal .040" Thick  
 Finish: Matte  
 5.87 Sq. In. N.F.A./Sq. Ft.  
 Length: 12'  
 16 Pcs./Ctn.  
 1.92 Sqs./Ctn.  
 88 Lbs./Ctn.

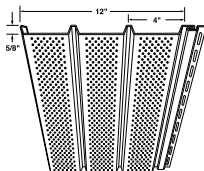

White

### Light Colors

Almond  
 Cameo  
 Classic Cream  
 Desert Sand  
 Linen  
 Sage  
 Sandtone  
 Silver Grey  
 Tuscan Olive  
 Victorian Grey  
 Wicker

### Classic Colors

Everest  
 Harbor Grey  
 Pebblestone Clay  
 Scottish Thistle

### Dark Color

Musket Brown

PTS12CV  
**Pro-Tech® Plus  
 Triple 4"  
 Center Ventilated Panel**

Nominal .040" Thick  
 Finish: Matte  
 1.96 Sq. In. N.F.A./Sq. Ft.  
 Length: 12'  
 16 Pcs./Ctn.  
 1.92 Sqs./Ctn.  
 89 Lbs./Ctn.

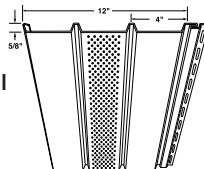

White

Notes:

# Pro-Tech® Plus Vinyl Soffit

---

## Product Code/Description

---

PTS10N  
**Pro-Tech® Plus  
Double 5"  
Non-Ventilated Panel**

Nominal .042" Thick  
Finish: Matte  
Length: 12'  
20 Pcs./Ctn.  
2 Sqs./Ctn.  
94 Lbs./Ctn.

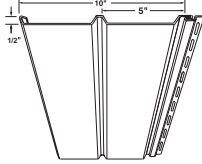

*(Pro-Tech D5 not warranted for sidewall use.)*

---

## Color Availability

---

White

**Light Colors**

Almond  
Cameo  
Classic Cream  
Desert Sand  
Linen  
Sage  
Sandtone  
Silver Grey  
Tuscan Olive  
Victorian Grey  
Wicker

**Classic Colors**

Everest  
Harbor Grey  
Pebblestone Clay  
Scottish Thistle

---

PTS10V  
**Pro-Tech® Plus  
Double 5"  
Ventilated Panel**

Nominal .042" Thick  
Finish: Matte  
7.53 Sq. In. N.F.A./Sq. Ft.  
Length: 12'  
20 Pcs./Ctn.  
2 Sqs./Ctn.  
91 Lbs./Ctn.

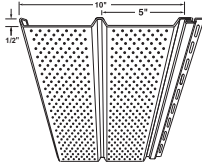

White

**Light Colors**

Almond  
Cameo  
Classic Cream  
Desert Sand  
Linen  
Sage  
Sandtone  
Silver Grey  
Tuscan Olive  
Victorian Grey  
Wicker

**Classic Colors**

Everest  
Harbor Grey  
Pebblestone Clay  
Scottish Thistle

---

## Notes:

# Universal Vinyl Soffit

---

## Product Code/Description

---

UVS12N

### Universal Triple 4" Non-Ventilated Panel

Nominal .036" Thick  
Finish: Matte  
Length: 12'  
16 Pcs./Ctn.  
1.92 Sqs./Ctn.  
80 Lbs./Ctn.

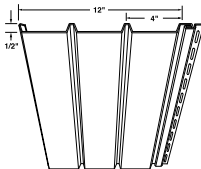

---

## Color Availability

---

White

### Light Colors

Almond  
Cameo  
Desert Sand  
Sandtone  
Wicker

### Classic Color

Pebblestone Clay

### Dark Color

Musket Brown

---

UVS12P

### Universal Triple 4" Ventilated Panel

Nominal .036" Thick  
Finish: Matte  
5.87 Sq. In. N.F.A./Sq. Ft.  
Length: 12'  
16 Pcs./Ctn.  
1.92 Sqs./Ctn.  
75 Lbs./Ctn.

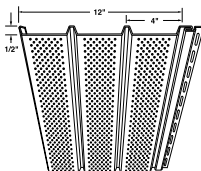

White

### Light Colors

Almond  
Cameo  
Desert Sand  
Sandtone  
Wicker

### Classic Color

Pebblestone Clay

### Dark Color

Musket Brown

---

UVS12CP

### Universal Triple 4" Center Ventilated Panel

Nominal .036" Thick  
Finish: Matte  
1.96 Sq. In. N.F.A./Sq. Ft.  
Length: 12'  
16 Pcs./Ctn.  
1.92 Sqs./Ctn.  
78 Lbs./Ctn.

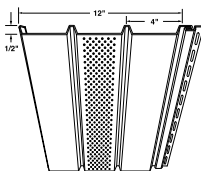

White

---

*(Universal T4 not warranted for sidewall use.)*

# Universal Vinyl Soffit

---

## Product Code/Description

---

TRMS10N  
**Universal  
Double 5"  
Non-Ventilated Panel**

Nominal .040" Thick  
Finish: Woodgrain  
Length: 12'  
20 Pcs./Ctn.  
2 Sqs./Ctn.  
90 Lbs./Ctn.

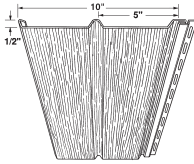

---

## Color Availability

---

White

---

### Light Colors

Almond  
Cameo  
Desert Sand  
Sandtone  
Wicker

---

### Classic Color

Pebblestone Clay

---

TRMS10V  
**Universal  
Double 5"  
Ventilated Panel**

Nominal .040" Thick  
Finish: Woodgrain  
7.53 Sq. In. N.F.A./Sq. Ft.  
Length: 12'  
20 Pcs./Ctn.  
2 Sqs./Ctn.  
87 Lbs./Ctn.

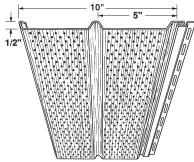

White

---

### Light Colors

Almond  
Cameo  
Desert Sand  
Sandtone  
Wicker

---

### Classic Color

Pebblestone Clay

---

*(Universal D5 Soffit not warranted for sidewall use.)*

# Vinyl Soffit Accessories

## Product Code/Description

MVJ051

### All Purpose J-Channel - 5/8" 1" Face

Length: 12' 6"  
40 Pcs./Ctn.  
45 Lbs./Ctn.

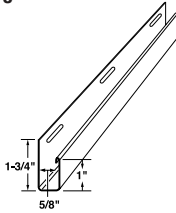

MVJ04

### Soffit J-Channel - 1/2"

Length: 12' 6"  
40 Pcs./Ctn.  
41 Lbs./Ctn.

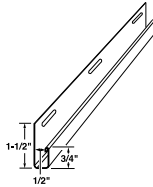

VFR05

### 5/8" "F" Channel

Length: 12' 6"  
24 Pcs./Ctn.  
40 Lbs./Ctn.

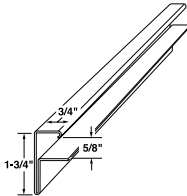

MFCH04

### 1/2" "F" Channel

Length: 12' 6"  
40 Pcs./Ctn.  
46 Lbs./Ctn.

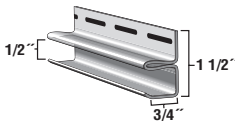

## Color Availability

White

### Light Colors

Almond  
Cameo  
Classic Cream  
Colonial Yellow  
Desert Sand  
Linen  
Sage  
Sandtone  
Silver Grey  
Tuscan Olive  
Victorian Grey  
Wicker

### Classic Colors

Corn Silk  
Everest  
Harbor Grey  
Pebblestone Clay  
Scottish Thistle

### Deep Colors

Autumn Harvest  
Deep Granite  
English Wedgewood

Lakeshore Fern  
Misty Shadow  
Montana Suede  
Portsmouth Blue  
Quiet Willow  
Rugged Canyon  
Russet Red  
Vineyard Grove

### Dark Color

Musket Brown

### Cedar Colors

American Walnut  
Cape Cod Grey  
Glacier Blue  
Natural Cedar  
Timberstone  
Woodland Green

### SolarDefense

Brandy Wood  
Mahogany  
Natural Slate  
Newport Bay  
Red Brick

White

### Light Colors

Almond  
Cameo  
Desert Sand  
Sandtone  
Wicker

### Classic Color

Pebblestone Clay

### Dark Color

Musket Brown

White

### Light Colors

Almond  
Cameo  
Desert Sand  
Sage  
Sandtone  
Wicker

### Classic Color

Pebblestone Clay

### Dark Color

Musket Brown

White

# Vinyl Soffit Accessories

Product Code/Description

Color Availability

MVTC05  
**"T" Channel - 5/8"**

Length: 12' 6"  
 12 Pcs./Ctn.  
 33 Lbs./Ctn.

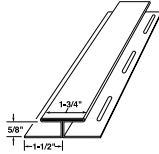

White

**Light Colors**

Almond  
 Cameo  
 Desert Sand  
 Sandtone  
 Wicker

**Classic Color**

Pebblestone Clay

**Dark Color**

Musket Brown

SCMNT126  
**Snap-In Crown Mount**

Length: 12' 6"  
 40 Pcs./Ctn.  
 46 Lbs./Ctn.

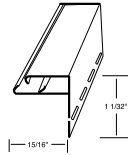

White

JSCMNT126  
**Snap-In Crown Mount with J-Channel**

Length: 12' 6"  
 40 Pcs./Ctn.  
 58 Lbs./Ctn.

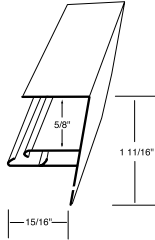

White

SCROWN126  
**Snap-In 3" Crown**

Length: 12' 6"  
 20 Pcs./Ctn.  
 55 Lbs./Ctn.

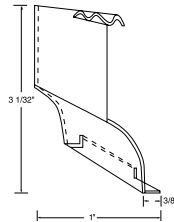

White

**Light Colors**

Cameo  
 Desert Sand  
 Wicker

**Classic Color**

Pebblestone Clay

Notes:

---

Notes:

# Shutters Standard 12" Raised Panel

## Product Code/Description

### Standard Raised Panel Shutters

12" Wide (Nominal)  
High Density Copolymer  
Baked-on Acrylic Finish  
1 Pair/Ctn.

VINRP1227

Length 27" • 6 Lbs./Ctn.

VINRP1231

Length 31" • 7 Lbs./Ctn.

VINRP1235

Length 35" • 8 Lbs./Ctn.

VINRP1239

Length 39" • 8 Lbs./Ctn.

VINRP1243

Length 43" • 9 Lbs./Ctn.

VINRP1247

Length 47" • 10 Lbs./Ctn.

VINRP1251

Length 51" • 11 Lbs./Ctn.

VINRP1255

Length 55" • 12 Lbs./Ctn.

VINRP1259

Length 59" • 12 Lbs./Ctn.

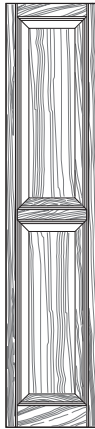

Regular Style

VINRP1263

Length 63" • 13 Lbs./Ctn.

VINRP1267

Length 67" • 13 Lbs./Ctn.

VINRP1271

Length 71" • 15 Lbs./Ctn.

## Color Availability

11	White
33	Black
99	Blackwatch Green
41	Blue
59	Brown
BLU	Coastal Blue
IJ	Dark Berry
95	Dark Navy
56	Dark Spruce
55	Green
16	Grey
52	Pebblestone Clay
PE	Peppercorn
38	Red
CRM	Sand Dollar
93	Spanish Moss
SL	Terra Brown
SK	Vineyard Red
58	Winestone

### Notes:

All shutter dimensions are nominal.

All louvered and raised panel shutter cartons include

3" painted steel mounting screws and shutter plugs.

Shutter touch-up paint available. See page 59.

### Notes:

# Shutters Standard 12" Louvered

---

## Product Code/Description

---

### Standard Open Louvered Shutters

12" Wide (Nominal)  
High Density Copolymer  
Baked-on Acrylic Finish  
1 Pair/Ctn.

---

VINLV1255

Length 55" • 12 Lbs./Ctn.

---

VINLV1259

Length 59" • 12 Lbs./Ctn.



Regular Style

---

## Color Availability

---

11	White
33	Black
99	Blackwatch Green
41	Blue
59	Brown
BLU	Coastal Blue
IJ	Dark Berry
95	Dark Navy
56	Dark Spruce
55	Green
16	Grey
52	Pebblestone Clay
PE	Peppercorn
38	Red
CRM	Sand Dollar
93	Spanish Moss
SL	Terra Brown
SK	Vineyard Red
58	Winestone

*Notes:*

*All shutter dimensions are nominal.*

*All louvered and raised panel shutter cartons include 3" painted steel mounting screws and shutter plugs.*

*Shutter touch-up paint available. See page 59.*

---

**Notes:**

# Shutters Standard 11" - 12"

## Board + Batten

---

### Product Code/Description

---

#### Board & Batten Standard 3-Board Shutters

11"-12" Wide (Nominal), High Density Copolymer, Baked-on Acrylic Finish, 1 Pair/Ctn.

CLOSED	OPEN
VIN3C1131 11"x31" • 4.5 Lbs./Ctn.	VIN301231 12"x31" • 4.5 Lbs./Ctn.
VIN3C1135 11"x35" • 5 Lbs./Ctn.	VIN301235 12"x35" • 5 Lbs./Ctn.
VIN3C1139 11"x39" • 5 Lbs./Ctn.	VIN301239 12"x39" • 5 Lbs./Ctn.
VIN3C1143 11"x43" • 5.5 Lbs./Ctn.	VIN301243 12"x43" • 6 Lbs./Ctn.
VIN3C1147 11"x47" • 6 Lbs./Ctn.	VIN301247 12"x47" • 6 Lbs./Ctn.
VIN3C1151 11"x51" • 6 Lbs./Ctn.	VIN301251 12"x51" • 6.5 Lbs./Ctn.
VIN3C1155 11"x55" • 7 Lbs./Ctn.	VIN301255 12"x55" • 7.5 Lbs./Ctn.
VIN3C1159 11"x59" • 7.5 Lbs./Ctn.	VIN301259 12"x59" • 8 Lbs./Ctn.
VIN3C1163 11"x63" • 8 Lbs./Ctn.	VIN301263 12"x63" • 8 Lbs./Ctn.
VIN3C1167 11"x67" • 8.5 Lbs./Ctn.	VIN301267 12"x67" • 8.5 Lbs./Ctn.
VIN3C1171 11"x71" • 9 Lbs./Ctn.	VIN301271 12"x71" • 9 Lbs./Ctn.
VIN3C1175 11"x75" • 9 Lbs./Ctn.	VIN301275 12"x75" • 9.5 Lbs./Ctn.
VIN3C1181 11"x81" • 10 Lbs./Ctn.	VIN301281 12"x81" • 10 Lbs./Ctn.

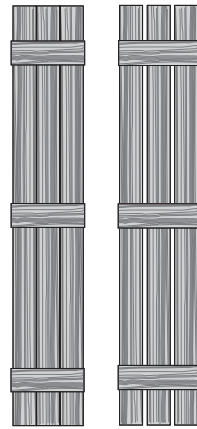

Closed Style

Open Style

---

### Color Availability

---

- 11 White
- 33 Black
- 99 Blackwatch Green
- 41 Blue
- 59 Brown
- BLU Coastal Blue
- IJ Dark Berry
- 95 Dark Navy
- 56 Dark Spruce
- 55 Green
- 16 Grey
- 52 Pebblestone Clay
- PE Peppercorn
- 38 Red
- CRM Sand Dollar
- 93 Spanish Moss
- SL Terra Brown
- SK Vineyard Red
- 58 Winestone

**Notes:**

All shutter dimensions are nominal.

Board + Batten shutter cartons include steel mounting screws.

Shutter touch-up paint available. See page 59.

Lengths 51" and smaller have 2 horizontal boards.

Lengths 55" and longer have 3 horizontal boards.

# Shutters Standard 15" Raised Panel

## Product Code/Description

### Standard Raised Panel Shutters

15" Wide (Nominal)  
High Density Copolymer  
Baked-on Acrylic Finish  
1 Pair/Ctn.

VINRP1531

Length 31" • 6 Lbs./Ctn.

VINRP1535

Length 35" • 7 Lbs./Ctn.

VINRP1539

Length 39" • 8 Lbs./Ctn.

VINRP1543

Length 43" • 9 Lbs./Ctn.

VINRP1547

Length 47" • 9 Lbs./Ctn.

VINRP1551

Length 51" • 10 Lbs./Ctn.

VINRP1555

Length 55" • 10 Lbs./Ctn.

VINRP1559

Length 59" • 11 Lbs./Ctn.

VINRP1563

Length 63" • 12 Lbs./Ctn.

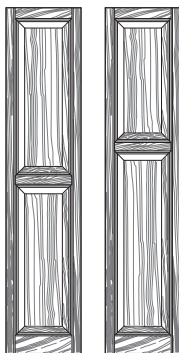

Regular Style Cottage Style

VINRP1567

Length 67" • 13 Lbs./Ctn.

VINRP1567C

Length 67" • 13 Lbs./Ctn.

VINRP1571

Length 71" • 13 Lbs./Ctn.

VINRP1575

Length 75" • 14 Lbs./Ctn.

VINRP1581

Length 81" • 15 Lbs./Ctn.

## Color Availability

- 11 White
- 33 Black
- 99 Blackwatch Green
- 41 Blue
- 59 Brown
- BLU Coastal Blue
- IJ Dark Berry
- 95 Dark Navy
- 56 Dark Spruce
- 55 Green
- 16 Grey
- 52 Pebblestone Clay
- PE Peppercorn
- 38 Red
- CRM Sand Dollar
- 93 Spanish Moss
- SL Terra Brown
- SK Vineyard Red
- 58 Winestone

DESIGNER ACCENTS™

### ARCH15RP 15" Raised Panel Arch Top

1 Pair/Ctn.  
3 Lbs./Ctn.

*\*For standard shutters only*

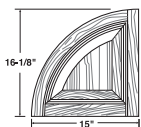

### TRANRP15 15" Raised Panel Transom Top

1 Pair/Ctn.  
3 Lbs./Ctn.

*\*For standard shutters only*

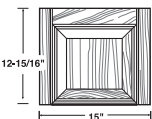

- 11 White
- 33 Black
- 99 Blackwatch Green
- 41 Blue
- 59 Brown
- BLU Coastal Blue
- IJ Dark Berry
- 95 Dark Navy
- 56 Dark Spruce
- 55 Green
- 16 Grey
- 52 Pebblestone Clay
- PE Peppercorn
- 38 Red
- CRM Sand Dollar
- 93 Spanish Moss
- SL Terra Brown
- SK Vineyard Red
- 58 Winestone

#### Notes:

All shutter dimensions are nominal.

All lowered and raised panel shutter cartons include

3" painted steel mounting screws and shutter plugs.

Shutter touch-up paint available. See page 59.

Not for use with custom shutters

# Shutters Standard 15" Louvered

## Product Code/Description

### Standard Open Louvered Shutters

15" Wide (Nominal)  
High Density Copolymer  
Baked-on Acrylic Finish  
1 Pair/Ctn.

VINLV1525

Length 25" • 5 Lbs./Ctn.

VINLV1531

Length 31" • 6 Lbs./Ctn.

VINLV1535

Length 35" • 7 Lbs./Ctn.

VINLV1539

Length 39" • 7 Lbs./Ctn.

VINLV1543

Length 43" • 8 Lbs./Ctn.

VINLV1547

Length 47" • 8 Lbs./Ctn.

VINLV1551

Length 51" • 9 Lbs./Ctn.

VINLV1555

Length 55" • 11 Lbs./Ctn.

VINLV1559

Length 59" • 11 Lbs./Ctn.

VINLV1563

Length 63" • 11 Lbs./Ctn.

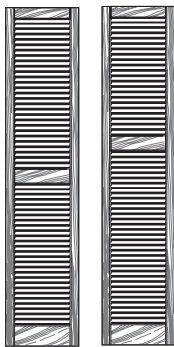

Regular Style Cottage Style

VINLV1567

Length 67" • 12 Lbs./Ctn.

VINLV1567C

Length 67" • 12 Lbs./Ctn.

VINLV1571

Length 71" • 12 Lbs./Ctn.

VINLV1575

Length 75" • 14 Lbs./Ctn.

VINLV1581

Length 81" • 14 Lbs./Ctn.

## Color Availability

- 11 White
- 33 Black
- 99 Blackwatch Green
- 41 Blue
- 59 Brown
- BLU Coastal Blue
- IJ Dark Berry
- 95 Dark Navy
- 56 Dark Spruce
- 55 Green
- 16 Grey
- 52 Pebblestone Clay
- PE Peppercorn
- 38 Red
- CRM Sand Dollar
- 93 Spanish Moss
- SL Terra Brown
- SK Vineyard Red
- 58 Winestone

**Notes:**

All shutter dimensions are nominal.

All louvered and raised panel shutter cartons include

3" painted steel mounting screws and shutter plugs.

Shutter touch-up paint available. See page 59.

**Notes:**

# Shutters Standard 15"-16"

## Board + Batten

### Product Code/Description

#### Board & Batten Standard 4-Board Shutters

15"-16" Wide (Nominal), High Density Copolymer, Baked-on Acrylic Finish, 1 Pair/Ctn.

CLOSED	OPEN
VIN4C1531 15"x31" • 6 Lbs./Ctn.	VIN401631 16"x31" • 6 Lbs./Ctn.
VIN4C1535 15"x35" • 6.5 Lbs./Ctn.	VIN401635 16"x35" • 6.5 Lbs./Ctn.
VIN4C1539 15"x39" • 7 Lbs./Ctn.	VIN401639 16"x39" • 7 Lbs./Ctn.
VIN4C1543 15"x43" • 7.5 Lbs./Ctn.	VIN401643 16"x43" • 7.5 Lbs./Ctn.
VIN4C1547 15"x47" • 8 Lbs./Ctn.	VIN401647 16"x47" • 8 Lbs./Ctn.
VIN4C1551 15"x51" • 8.5 Lbs./Ctn.	VIN401651 16"x51" • 8.5 Lbs./Ctn.
VIN4C1555 15"x55" • 10 Lbs./Ctn.	VIN401655 16"x55" • 10 Lbs./Ctn.
VIN4C1559 15"x59" • 10 Lbs./Ctn.	VIN401659 16"x59" • 10.5 Lbs./Ctn.
VIN4C1563 15"x63" • 10.5 Lbs./Ctn.	VIN401663 16"x63" • 11 Lbs./Ctn.
VIN4C1567 15"x67" • 11 Lbs./Ctn.	VIN401667 16"x67" • 11.5 Lbs./Ctn.
VIN4C1571 15"x71" • 11.5 Lbs./Ctn.	VIN401671 16"x71" • 12 Lbs./Ctn.
VIN4C1575 15"x75" • 12 Lbs./Ctn.	VIN401675 16"x75" • 12.5 Lbs./Ctn.
VIN4C1581 15"x81" • 13 Lbs./Ctn.	VIN401681 16"x81" • 13 Lbs./Ctn.

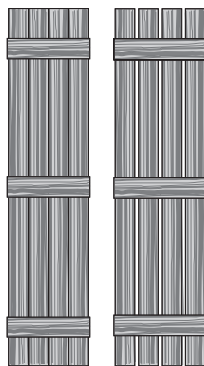

Closed Style

Open Style

### Color Availability

- 11 White
- 33 Black
- 99 Blackwatch Green
- 41 Blue
- 59 Brown
- BLU Coastal Blue
- IJ Dark Berry
- 95 Dark Navy
- 56 Dark Spruce
- 55 Green
- 16 Grey
- 52 Pebblestone Clay
- PE Peppercorn
- 38 Red
- CRM Sand Dollar
- 93 Spanish Moss
- SL Terra Brown
- SK Vineyard Red
- 58 Winestone

#### Notes:

All shutter dimensions are nominal.

Board + Batten shutter cartons include steel mounting screws.

Shutter touch-up paint available. See page 59.

Lengths 51" and shorter have 2 horizontal boards.

Lengths 55" and longer have 3 horizontal boards.

# Shutters Arched Top 14"

## Board + Batten

---

### Product Code/Description

---

#### Arch Top Board + Batten Shutter

14" Wide (Nominal), High Density Copolymer, Baked-on Acrylic Finish, 1 Pair/Ctn.

---

BBARCH41

Length 41" • 7 Lbs./Ctn.

---

BBARCH43

Length 43" • 7.5 Lbs./Ctn.

---

BBARCH57

Length 57" • 9.5 Lbs./Ctn.

---

BBARCH61

Length 61" • 10 Lbs./Ctn.

---

BBARCH65

Length 65" • 10.5 Lbs./Ctn.

---

BBARCH71

Length 71" • 11.5 Lbs./Ctn.

---

BBARCH73

Length 73" • 12 Lbs./Ctn.

---

BBARCH77

Length 77" • 12.5 Lbs./Ctn.

---

BBARCH85

Length 85" • 13 Lbs./Ctn.

---

#### Notes:

All shutter dimensions are nominal.

Board + Batten shutter cartons include steel mounting screws.

Shutter touch-up paint available. See page 59.

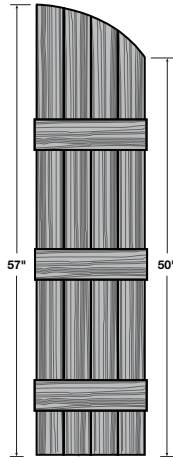

---

### Color Availability

---

11	White
33	Black
99	Blackwatch Green
41	Blue
59	Brown
BLU	Coastal Blue
IJ	Dark Berry
95	Dark Navy
56	Dark Spruce
55	Green
16	Grey
52	Pebblestone Clay
PE	Peppercorn
38	Red
CRM	Sand Dollar
93	Spanish Moss
SL	Terra Brown
SK	Vineyard Red
58	Winstone

---

### Notes:

# Shutters Custom

## Product Code/Description

### Custom Open Louvered Panel Shutters

9", 12" or 15" Wide (Nominal)  
High Density Copolymer  
Baked-on Acrylic Finish  
1 Pair/Ctn.

#### Product Code

Example: CLV1530

CLV1530 = CLV + width + length

Custom Louvered Panel = CLV

Width = 15

Length = 30



Regular Style

**Notes:**

All shutter dimensions are nominal.

All louvered and raised panel shutter cartons include

3" painted steel mounting screws and shutter plugs.

Shutter touch-up paint available. See page 59.

## Color Availability

- 11 White
- 33 Black
- 99 Blackwatch Green
- 41 Blue
- 59 Brown
- BLU Coastal Blue
- IJ Dark Berry
- 95 Dark Navy
- 56 Dark Spruce
- 55 Green
- 16 Grey
- 52 Pebblestone Clay
- PE Peppercorn
- 38 Red
- CRM Sand Dollar
- 93 Spanish Moss
- SL Terra Brown
- SK Vineyard Red
- 58 Winestone

## Length

- 18
- 19
- 20
- 21
- 22
- 23
- 24
- 25
- 26
- 27
- 28
- 29
- 30
- 31
- 32
- 33
- 34
- 35
- 36
- 37
- 38

### Custom Raised Panel Shutters

12" or 15" Wide (Nominal)  
High Density Copolymer  
Baked-on Acrylic Finish  
1 Pair/Ctn.

#### Product Code

Example: CRP1530

CRP1530 = CRP + width + length

Custom Raised Panel = CRP

Width = 15

Length = 30

Lengths available: 18"-96"



Regular Style

**Notes:**

All shutter dimensions are nominal.

All louvered and raised panel shutter cartons include

3" painted steel mounting screws and shutter plugs.

Shutter touch-up paint available. See page 59.

- 11 White
- 33 Black
- 99 Blackwatch Green
- 41 Blue
- 59 Brown
- BLU Coastal Blue
- IJ Dark Berry
- 95 Dark Navy
- 56 Dark Spruce
- 55 Green
- 16 Grey
- 52 Pebblestone Clay
- PE Peppercorn
- 38 Red
- CRM Sand Dollar
- 93 Spanish Moss
- SL Terra Brown
- SK Vineyard Red
- 58 Winestone

- 39
- 40
- 41
- 42
- 43
- 44
- 45
- 46
- 47
- 48
- 49
- 50
- 51
- 52
- 53
- 54
- 55
- 56
- 57

# Shutters Accessories

## Product Code/Description

ARCH15LV  
**15" Open Louvered  
 Arch Top**  
 1 Pair/Ctn.  
 3 Lbs./Ctn.

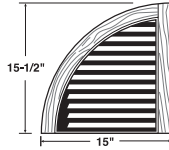

*\*For standard shutters only*

## Color Availability

- 11 White
- 33 Black
- 99 Blackwatch Green
- 41 Blue
- 59 Brown
- BLU Coastal Blue
- IJ Dark Berry
- 95 Dark Navy
- 56 Dark Spruce
- 55 Green
- 16 Grey
- 52 Pebblestone Clay
- PE Peppercorn
- 38 Red
- CRM Sand Dollar
- 93 Spanish Moss
- SL Terra Brown
- SK Vineyard Red
- 58 Winestone

## SHUTPAINT

**Touch-Up Paint for Shutters  
 (Bottled with brush)**

1 oz./Plastic Bottle  
 1 /Ctn.



- 11 White
- 33 Black
- 99 Blackwatch Green
- 41 Blue
- 59 Brown
- BLU Coastal Blue
- IJ Dark Berry
- 95 Dark Navy
- 56 Dark Spruce
- 55 Green
- 16 Grey
- 52 Pebblestone Clay
- PE Peppercorn
- 38 Red
- CRM Sand Dollar
- 93 Spanish Moss
- SL Terra Brown
- SK Vineyard Red
- 58 Winestone

Notes:

DESIGNER ACCENTS™

# Shutters Accessories

## Product Code/Description

### SHUTTRPLUG Fastener

1/4" x 2-5/8"  
12 Pcs./Pkg.

*Shutter touch-up paint available  
in standard colors.*

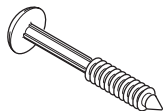

## Color Availability

11 White  
33 Black  
99 Blackwatch Green  
41 Blue  
59 Brown  
BLU Coastal Blue  
IJ Dark Berry  
95 Dark Navy  
56 Dark Spruce  
55 Green  
16 Grey  
52 Pebblestone Clay  
PE Peppercorn  
38 Red  
CRM Sand Dollar  
93 Spanish Moss  
SL Terra Brown  
SK Vineyard Red  
58 Winestone

DESIGNER ACCENTS™

### VINITT Painted Steel Replacement Screws

3/16" x 3"  
4 Pcs./Pkg.

*Shutter touch-up paint available  
in standard colors.*



11 White  
33 Black  
99 Blackwatch Green  
41 Blue  
59 Brown  
BLU Coastal Blue  
IJ Dark Berry  
95 Dark Navy  
56 Dark Spruce  
55 Green  
16 Grey  
52 Pebblestone Clay  
PE Peppercorn  
38 Red  
CRM Sand Dollar  
93 Spanish Moss  
SL Terra Brown  
SK Vineyard Red  
58 Winestone

### SHTCLP12 Shutter Clips and Anchors

12 pc = 1 ea  
50 ea = 1 ct

*For standard shutters only*



Mill Finish

### SHOOK Hooks and Hinges

Includes (4) Hinges,  
(2) S-Hooks (right and left)  
and (10) Screws

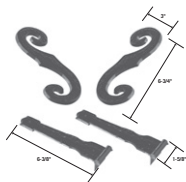

33 Black

# Door Surround Systems

---

## Product Code/Description

---

## Color Availability

### PEDIMENTST Pediment Set

Pediment Height: 12-3/4"  
 Overall Height: 18-1/2"  
 1 Pc./Ctn.  
 8 Lbs./Ctn.

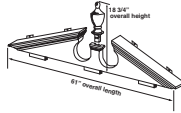

11 White (paintable)

### MANTEL Door Surround Mantel

Length: 58"  
 1 Pc./Ctn.  
 7.41 Lbs./Ctn.

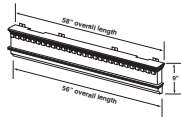

11 White (paintable)

### MANTELOVLY Door Mantel Overlay

Length: 10-1/2"  
 6 Pcs./Ctn.  
 6.24 Lbs./Ctn.

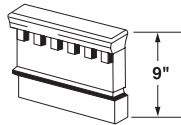

11 White (paintable)

### TOPCAP Pilaster Cap

1 Pc./Ctn.  
 .23 Lb./Ctn.

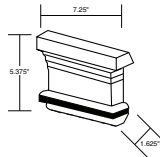

11 White (paintable)

### BASECAP Pilaster Base

1 Pc./Ctn.  
 .56 Lb./Ctn.

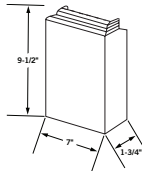

11 White (paintable)

Notes:

# Door Surround Systems

---

## Product Code/Description

---

PILASTER96

### 96" Pilaster Set

- 2 Pilasters
- 6 Mounting Clips
- 2 Pilaster Caps
- 2 Pilaster Bases

Width: 7-1/2"

Height: 96"

1 Pair/Ctn.

15.49 Lbs./Ctn.

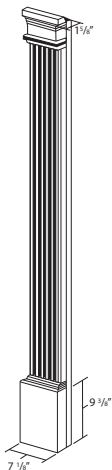

---

## Color Availability

---

11 White (paintable)

DESIGNER ACCENTS™

PILASTER144

### 144" Pilaster Set

- 2 Pilasters
- 6 Mounting Clips
- 2 Pilaster Caps
- 2 Pilaster Bases

Width: 7-1/2"

Height: 144"

1 Pair/Ctn.

19.71 Lbs./Ctn.

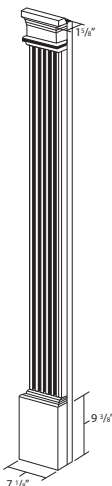

11 White (paintable)

---

Notes:

# Mantel Systems

Product Code/Description

Color Availability

MANTEL120

## 120" Mantel System

11 White (paintable)

Mantel

Face Height: 7-3/8"

Length: 120"

Plain Cover Strip

Height: 1"

Length: 120"

Thickness: .139

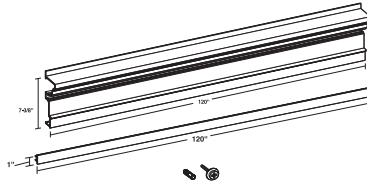

1 Mantel System/Ctn.

15.25 Lbs./Ctn.

Mantel System Includes:

1 – Mantel (120")

1 – Plain Cover Strip (120")

16 – (8) Anchors and (8) Screw/Washers

DENTILSTP

## 60" Dentil Strip

11 White (paintable)

Height: 1"

Length: 60"

2 Pcs./Ctn.

2.4 Lbs./Ctn.

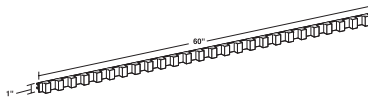

KEYSTN

## Keystone for 120" Mantel System

11 White (paintable)

Height: 7-1/2"

Top Width: 7"

Bottom Length: 4-3/4"

1 Pc./Ctn.

1.26 Lb./Ctn.

(includes mounting hardware)

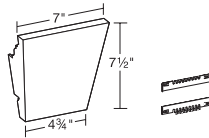

SDGENDCAP

## Siding Endcaps for 120" Mantel System

11 White (paintable)

Height: 7-3/8"

Width: 3-1/4"

2 Pcs./Ctn.

2.98 Lbs./Ctn.

(includes adhesive)

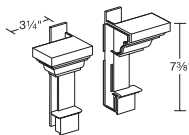

# Mantel Systems

---

Product Code/Description

---

BRKENDCAP  
**Brick Endcaps for 120"**  
**Mantel System**

Height: 7-3/8"  
Width: 3-1/4"  
2 Pcs./Ctn.  
3.06 Lbs./Ctn.  
(includes adhesive)

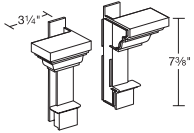

---

Color Availability

---

11 White (paintable)

---

Notes:

DESIGNER ACCENTS™

# Window Mantels

Product Code/Description

Color Availability

## 36" 40" 44" Window Mantel

11 White (paintable)

Height: 7-1/4"  
1 Pc./Ctn.

PLWINMTL36  
Length 36" • 6 Lbs./Ctn.

PLWINMTL40  
Length 40" • 6.54 Lbs./Ctn.

PLWINMTL44  
Length 44" • 7 Lbs./Ctn.

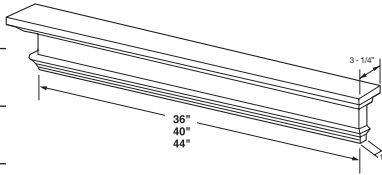

## 36" 40" 44" Window Mantel with Dentil Trim

11 White (paintable)

Height: 7-1/4"  
1 Pc./Ctn.

DTWINMTL36  
Length 36" • 6 Lbs./Ctn.

DTWINMTL40  
Length 40" • 6.54 Lbs./Ctn.

DTWINMTL44  
Length 44" • 7 Lbs./Ctn.

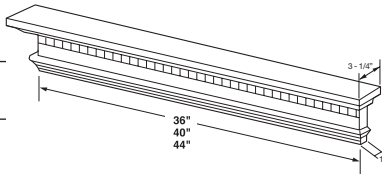

## KEYSTONE Keystone for Window Mantel

11 White (paintable)

Height: 8-3/4"  
Length: 7-3/4"  
1 Pc./Ctn.  
1.43 Lb./Ctn.

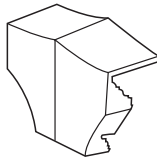

## ENDCAP Endcap for Window Mantel

11 White (paintable)

1 Pc./Ctn.  
.82 Lb./Ctn.  
(includes adhesive)

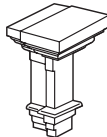

# Mounting Blocks

## Product Code/Description

### UNIBLOCK

#### J-Block® Square Mounting Block

Surface Dimensions:

5" x 6"

Flange Dimensions:

7-3/16" x 8-3/16"

J-Channel I.D.:

1/2" adjusts to 1-1/4"

Knockouts

Round: 4" Diameter

Rectangle: 2-3/8" x 3-3/4"

10 Pcs./Ctn.

6 Lbs./Ctn.

Uses: Light Fixtures, Electrical Receptacles, Water Faucets

An additional 100 colors are available to match or coordinate with leading siding manufacturer's colors. For additional colors, see "Designer Accents Color Matrix" on page 88.

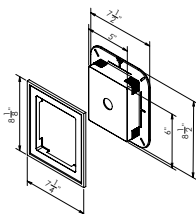

### MBLOCK

#### Mini J-Block® Mounting Block

Surface Dimensions:

6" x 4-3/8"

Flange Dimensions:

6 7/8" x 5-1/4"

J-Channel I.D.:

3/4" adjusts to 1-1/4"

Knockouts

Round: 1-1/8" Diameter

Rectangle: 2-3/8" x 3-3/4"

10 Pcs./Ctn.

3 Lbs./Ctn.

Uses: Doorbell, Electrical Outlet

An additional 100 colors are available to match or coordinate with leading siding manufacturer's colors. For additional colors, see "Designer Accents Color Matrix."

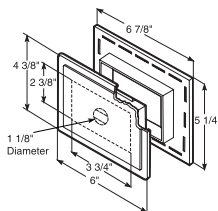

## Color Availability

11	Paintable White
53	Almond
350	Alpine Forest
E9	American Walnut/Walnut*
EX	Aspen Grey*
251	Autumn Harvest
147	Brandy Wood
31	Cameo
36	Cape Cod Grey/Cape Grey*
30	Classic Cream
10	Colonial Yellow
210	Corn Silk
352	Deep Cavern
090	Deep Granite
22	Desert Sand
390	English Wedgewood
17	Everest
E6	Glacier Blue*
35	Harbor Gray
IC	Lakeshore Fern
44	Linen
148	Mahogany
144	Misty Shadow
IF	Montana Suede
N5	Musket Brown
100	Natural Cedar/Cedar*
156	Natural Slate
146	Newport Bay
52	Pebblestone Clay
IB	Portsmouth Blue
170	Quiet Willow
149	Red Brick
ID	Red Cedar
353	Rock Harbor
100	Rugged Canyon
290	Russet Red
18	Sage
39	Sandtone
510	Scottish Thistle
02	Silver Grey
ID	Terra Cotta
E7	Timberstone/Timber*
511	Tuscan Olive
36	Victorian Grey
252	Vineyard Grove
354	Whispering Timber
04	White
A7	Wicker
E4	Woodland Green*
355	Woodland Retreat

\*Recommended solid color match for a variegated color.

# Mounting Blocks

## Product Code/Description

### UNIBLOCKSC J-Block® Square Mounting Block Scroll 4" Knockout

Surface Dimensions:  
5" x 6"  
Flange Dimensions:  
7-3/16" x 8-3/16"  
J-Channel I.D.:  
1/2" adjusts to 1-1/4"  
Knockouts  
Round: 4" Diameter  
Rectangle: 2-3/8" x 3-3/4"  
10 Pcs./Ctn.  
6 Lbs./Ctn.

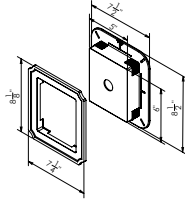

Uses: Light Fixtures, Electrical Receptacles, Water Faucets

An additional 100 colors are available to match or coordinate with leading siding manufacturer's colors. For additional colors, see "Designer Accents Color Matrix."

### MBLOCKR Split Recessed J-Block® Mounting Block

Surface Dimensions:  
5-5/8" x 7-3/8"  
Flange Dimensions:  
6" x 7-1/2"  
J-Channel I.D.:  
3/4" adjusts to 1-1/4"  
Knockouts  
Rectangle: 2-1/4" x 3-7/8"  
10 Pcs./Ctn.  
3.4 Lbs./Ctn.

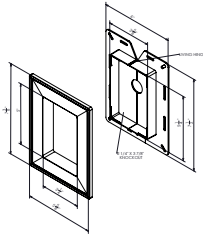

Uses: Faucets, Electrical Outlet

An additional 100 colors are available to match or coordinate with leading siding manufacturer's colors. For additional colors, see "Designer Accents Color Matrix." Hinged

## Color Availability

11	Paintable White
53	Almond
350	Alpine Forest
E9	American Walnut/Walnut
EX	Aspen Grey
251	Autumn Harvest
147	Brandy Wood
31	Cameo
36	Cape Cod Grey/Cape Grey
30	Classic Cream
10	Colonial Yellow
210	Corn Silk
352	Deep Cavern
090	Deep Granite
22	Desert Sand
390	English Wedgewood
17	Everest
E6	Glacier Blue
35	Harbor Gray
IC	Lakeshore Fern
44	Linen
148	Mahogany
144	Misty Shadow
IF	Montana Suede
N5	Musket Brown
100	Natural Cedar/Cedar
156	Natural Slate
146	Newport Bay
52	Pebblestone Clay
IB	Portsmouth Blue
170	Quiet Willow
149	Red Brick
ID	Red Cedar
353	Rock Harbor
100	Rugged Canyon
290	Russet Red
18	Sage
39	Sandtone
510	Scottish Thistle
02	Silver Grey
ID	Terra Cotta
E7	Timberstone/Timber
511	Tuscan Olive
36	Victorian Grey
252	Vineyard Grove
354	Whispering Timber
04	White
A7	Wicker
E4	Woodland Green
355	Woodland Retreat

\*Recommended solid color match for a variegated color.

# Mounting Blocks

## Product Code/Description

### JMBLOCK

#### Large J-Block® Mounting Block

Surface Dimensions:

8-3/8" x 12-1/2"

Base Dimensions:

6" x 10-1/8"

J-Channel I.D.:

1/2" to 1-1/4"

5 Pcs./Ctn.

4 Lbs./Ctn.

Flange Depth:

1-1/2"

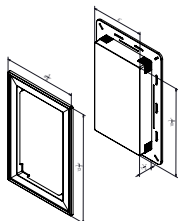

Uses: Light Fixtures, Mailbox, House Numbers

Can be used with insulated siding

Does not include electrical box

### JMBLOCKSC

#### Large J-Block® Mounting Block with Scroll Cut Square

Surface Dimensions:

8-3/8" x 12-1/2"

Base Dimensions:

6" x 10-1/8"

J-Channel I.D.:

1/2" to 1-1/4"

5 Pcs./Ctn.

4 Lbs./Ctn.

Flange Depth:

1-1/2"

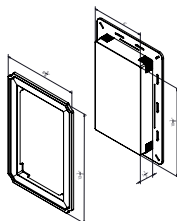

Uses: Light Fixtures, Mailbox, House Numbers

Can be used with insulated siding

Does not include electrical box

### UNIBLOCKXL

#### Large J-Block® Mounting Block

Mounting Surface:

9" x 16"

Outer Dimensions:

11-3/4" x 18-3/4"

J-Channel I.D.:

1/2" adjusts to 1-1/4"

Knockouts

Round: 4" Diameter

Rectangle: 2-3/8" x 3-3/4"

4 Pcs./Ctn.

51 Lbs./Ctn.

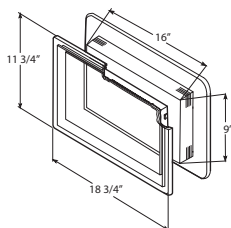

Uses: Light Fixtures, Mailbox, House Numbers

## Color Availability

11	Paintable White
53	Almond
350	Alpine Forest
E9	American Walnut/Walnut*
EX	Aspen Grey*
251	Autumn Harvest
147	Brandy Wood
31	Cameo
36	Cape Cod Grey/Cape Grey*
30	Classic Cream
10	Colonial Yellow
210	Corn Silk
352	Deep Cavern
090	Deep Granite
22	Desert Sand
390	English Wedgewood
17	Everest
E6	Glacier Blue*
35	Harbor Gray
IC	Lakeshore Fern
44	Linen
148	Mahogany
144	Misty Shadow
IF	Montana Suede
N5	Musket Brown
100	Natural Cedar/Cedar*
156	Natural Slate
146	Newport Bay
52	Pebblestone Clay
IB	Portsmouth Blue
170	Quiet Willow
149	Red Brick
ID	Red Cedar
353	Rock Harbor
100	Rugged Canyon
290	Russet Red
18	Sage
39	Sandtone
510	Scottish Thistle
02	Silver Grey
ID	Terra Cotta
E7	Timberstone/Timber*
511	Tuscan Olive
36	Victorian Grey
252	Vineyard Grove
354	Whispering Timber
04	White
A7	Wicker
E4	Woodland Green*
355	Woodland Retreat

\*Recommended solid color match for a variegated color.

# Mounting Blocks

## Product Code/Description

JMEBLOCK

### Large J-Block® Mounting Block with UL Electrical Box\*

Surface Dimensions:  
8-3/8" x 12-1/2"  
Base Dimensions:  
6" x 10-1/8"  
Adjusts 1/2" - 1-1/4"  
4 Pcs./Ctn.  
4.5 Lbs./Ctn.  
Flange Depth:  
1-7/8"

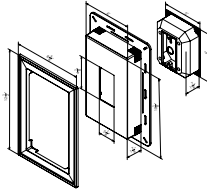

\*Includes UL approved black electrical box

JMEBLOCKSC

### Large J-Block® Mounting Block with UL Electrical Box Scroll Cut\*

Surface Dimensions:  
8-3/8" x 12-1/2"  
Base Dimensions:  
6" x 10-1/8"  
Adjusts 1/2" - 1-1/4"  
4 Pcs./Ctn.  
4.5 Lbs./Ctn.  
Flange Depth:  
1-7/8"

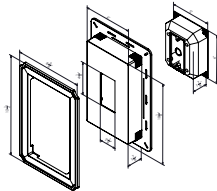

\*Includes UL approved black electrical box

JMEBLOCK

### Large J-Block® Mounting Block with UL Electrical Box Offset\*

Surface Dimensions:  
8-3/8" x 12-1/2"  
Base Dimensions:  
6" x 10-1/8"  
Adjusts 1/2" - 1-1/4"  
4 Pcs./Ctn.  
4.5 Lbs./Ctn.  
Flange Depth:  
1-7/8"

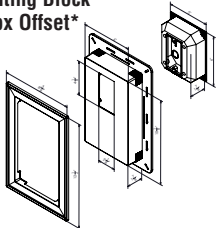

\*Includes UL approved black electrical box

JMEBLOCKSC

### Large J-Block® Mounting Block with UL Electrical Box Offset Scroll\*

Surface Dimensions:  
8-3/8" x 12-1/2"  
Base Dimensions:  
6" x 10-1/8"  
Adjusts 1/2" - 1-1/4"  
4 Pcs./Ctn.  
4.5 Lbs./Ctn.  
Flange Depth:  
1-7/8"

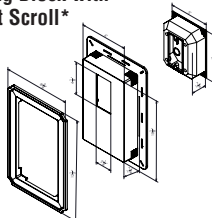

\*Includes UL approved black electrical box

## Color Availability

11	Paintable White
53	Almond
350	Alpine Forest
E9	American Walnut/Walnut
EX	Aspen Grey
251	Autumn Harvest
147	Brandy Wood
31	Cameo
36	Cape Cod Grey/Cape Grey
30	Classic Cream
10	Colonial Yellow
210	Corn Silk
352	Deep Cavern
090	Deep Granite
22	Desert Sand
390	English Wedgewood
17	Everest
E6	Glacier Blue
35	Harbor Gray
IC	Lakeshore Fern
44	Linen
148	Mahogany
144	Misty Shadow
IF	Montana Suede
N5	Musket Brown
100	Natural Cedar/Cedar
156	Natural Slate
146	Newport Bay
52	Pebblestone Clay
IB	Portsmouth Blue
170	Quiet Willow
149	Red Brick
ID	Red Cedar
353	Rock Harbor
100	Rugged Canyon
290	Russet Red
18	Sage
39	Sandtone
510	Scottish Thistle
02	Silver Grey
ID	Terra Cotta
E7	Timberstone/Timber
511	Tuscan Olive
36	Victorian Grey
252	Vineyard Grove
354	Whispering Timber
04	White
A7	Wicker
E4	Woodland Green
355	Woodland Retreat

\*Recommended solid color match for a variegated color.

# Mounting Blocks

## Product Code/Description

### METERLG

#### Jumbo Meter Base J-Block®

Mounting Surface:

20" x 24"

Outer Dimensions:

21-1/2" x 24-1/2"

J-Channel I.D.:

1/2" adjusts to 1-1/4"

1 Pcs./Ctn.

4 Lbs./Ctn.

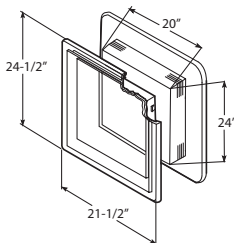

### METER

#### Meter Base J-Block®

Surface Dimensions:

16-1/2" x 15-1/2"

Flange Dimensions:

18-1/2" x 16-3/4"

J-Channel I.D.:

1-1/4"

5 Pcs./Ctn.

10 Lbs./Ctn.

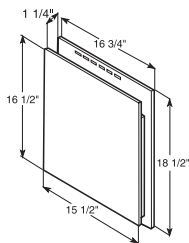

Uses: Hose Rack, Electric Meter Base

An additional 100 colors are available to match or coordinate with leading siding manufacturer's colors. For additional colors, see "Designer Accents Color Matrix."

## Color Availability

11	Paintable White
53	Almond
350	Alpine Forest
E9	American Walnut/Walnut*
EX	Aspen Grey*
251	Autumn Harvest
147	Brandy Wood
31	Cameo
36	Cape Cod Grey/Cape Grey*
30	Classic Cream
10	Colonial Yellow
210	Corn Silk
352	Deep Cavern
090	Deep Granite
22	Desert Sand
390	English Wedgewood
17	Everest
E6	Glacier Blue*
35	Harbor Gray
IC	Lakeshore Fern
44	Linen
148	Mahogany
144	Misty Shadow
IF	Montana Suede
N5	Musket Brown
100	Natural Cedar/Cedar*
156	Natural Slate
146	Newport Bay
52	Pebblestone Clay
IB	Portsmouth Blue
170	Quiet Willow
149	Red Brick
ID	Red Cedar
353	Rock Harbor
100	Rugged Canyon
290	Russet Red
18	Sage
39	Sandtone
510	Scottish Thistle
02	Silver Grey
ID	Terra Cotta
E7	Timberstone/Timber*
511	Tuscan Olive
36	Victorian Grey
252	Vineyard Grove
354	Whispering Timber
04	White
A7	Wicker
E4	Woodland Green*
355	Woodland Retreat

\*Recommended solid color match for a variegated color.

# Mounting Blocks

## Product Code/Description

EBLOCK

### UL Electrical Block

Surface Dimensions:

8-1/8" x 7-1/8"

Projection: 2-1/8"

Flange: 1-1/4"

Base Dimensions:

5-7/8" x 4-7/8"

Siding Receiver: 3/4"-1 1/4"

1 Pc./Ctn.

1 Lbs./Ctn.

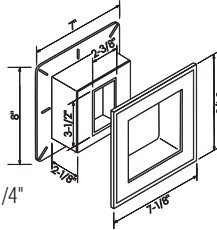

An additional 100 colors are available to match or coordinate with leading siding manufacturer's colors. For additional colors, see "Designer Accents Color Matrix."

## Color Availability

11	Paintable White
53	Almond
350	Alpine Forest
E9	American Walnut/Walnut
EX	Aspen Grey
251	Autumn Harvest
147	Brandy Wood
31	Cameo
36	Cape Cod Grey/Cape Grey
30	Classic Cream
10	Colonial Yellow
210	Corn Silk
352	Deep Cavern
090	Deep Granite
22	Desert Sand
390	English Wedgewood
17	Everest
E6	Glacier Blue
35	Harbor Gray
IC	Lakeshore Fern
44	Linen
148	Mahogany
144	Misty Shadow
IF	Montana Suede
N5	Musket Brown
100	Natural Cedar/Cedar
156	Natural Slate
146	Newport Bay
52	Pebblestone Clay
IB	Portsmouth Blue
170	Quiet Willow
149	Red Brick
ID	Red Cedar
353	Rock Harbor
100	Rugged Canyon
290	Russet Red
18	Sage
39	Sandtone
510	Scottish Thistle
02	Silver Grey
ID	Terra Cotta
E7	Timberstone/Timber
511	Tuscan Olive
36	Victorian Grey
252	Vineyard Grove
354	Whispering Timber
04	White
A7	Wicker
E4	Woodland Green
355	Woodland Retreat

*\*Recommended solid color match for a variegated color.*

---

Notes:

# E-Z Block™ Surface Mounts

## Product Code/Description

EZBLK070

### Square Surface Mount (Dutch Lap)

Surface Dimensions:

6-3/4" x 6-3/4"

Projections: 3/4"

Knockouts

Round: 1" Diameter

Rectangle: 2-3/8" x 3-3/4"

10 Pcs./Ctn.

4 Lbs./Ctn.

Uses: Light Fixtures, Electrical Outlets, Water Faucets

An additional 100 colors are available to match or coordinate with leading siding manufacturer's colors. For additional colors, see "Designer Accents Color Matrix."

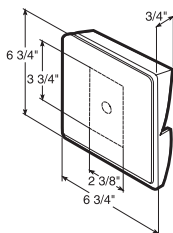

EZBLK080

### Octagon Surface Mount (Double 4" or Double 5")

Surface Dimensions:

6-3/4" x 6-3/4"

Projections: 3/4"

Knockouts

Round: 1" Diameter

Rectangle: 2-3/8" x 3-3/4"

10 Pcs./Ctn.

3.34 Lbs./Ctn.

Uses: Light Fixtures, Electrical Outlets, Water Faucets

An additional 100 colors are available to match or coordinate with leading siding manufacturer's colors. For additional colors, see "Designer Accents Color Matrix."

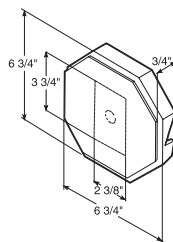

## Color Availability

11	Paintable White
53	Almond
350	Alpine Forest
E9	American Walnut/Walnut
EX	Aspen Grey
251	Autumn Harvest
147	Brandy Wood
31	Cameo
36	Cape Cod Grey/Cape Grey
30	Classic Cream
10	Colonial Yellow
210	Corn Silk
352	Deep Cavern
090	Deep Granite
22	Desert Sand
390	English Wedgewood
17	Everest
E6	Glacier Blue
35	Harbor Gray
IC	Lakeshore Fern
44	Linen
148	Mahogany
144	Misty Shadow
IF	Montana Suede
N5	Musket Brown
100	Natural Cedar/Cedar
156	Natural Slate
146	Newport Bay
52	Pebblestone Clay
IB	Portsmouth Blue
170	Quiet Willow
149	Red Brick
ID	Red Cedar
353	Rock Harbor
100	Rugged Canyon
290	Russet Red
18	Sage
39	Sandtone
510	Scottish Thistle
O2	Silver Grey
ID	Terra Cotta
E7	Timberstone/Timber
511	Tuscan Olive
36	Victorian Grey
252	Vineyard Grove
354	Whispering Timber
04	White
A7	Wicker
E4	Woodland Green
355	Woodland Retreat

\*Recommended solid color match for a variegated color.

# E-Z Block™ Surface Mounts

## Product Code/Description

EZBLK110

### Octagon Surface Mount (Dutch Lap)

Surface Dimensions:

6-3/4" x 6-3/4"

Projections: 3/4"

Knockouts

Round: 1" Diameter

Rectangle: 2-3/8" x 3-3/4"

10 Pcs./Ctn.

3.3 Lbs./Ctn.

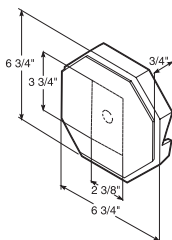

Uses: Light Fixtures, Electrical Outlets, Water Faucets

An additional 100 colors are available to match or coordinate with leading siding manufacturer's colors. For additional colors, see "Designer Accents Color Matrix."

EZBLK040

### Square Surface Mount (Double 4" or Double 5")

Surface Dimensions:

6-3/4" x 6-3/4"

Projections: 3/4"

Knockouts

Round: 1" Diameter

Rectangle: 2-3/8" x 3-3/4"

10 Pcs./Ctn.

4 Lbs./Ctn.

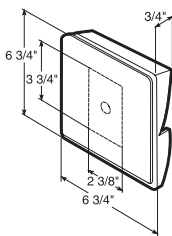

Uses: Light Fixtures, Electrical Receptacles, Water Faucets

An additional 100 colors are available to match or coordinate with leading siding manufacturer's colors. For additional colors, see "Designer Accents Color Matrix."

## Color Availability

11	Paintable White
53	Almond
350	Alpine Forest
E9	American Walnut/Walnut*
EX	Aspen Grey*
251	Autumn Harvest
147	Brandy Wood
31	Cameo
36	Cape Cod Grey/Cape Grey*
30	Classic Cream
10	Colonial Yellow
210	Corn Silk
352	Deep Cavern
090	Deep Granite
22	Desert Sand
390	English Wedgewood
17	Everest
E6	Glacier Blue*
35	Harbor Gray
IC	Lakeshore Fern
44	Linen
148	Mahogany
144	Misty Shadow
IF	Montana Suede
N5	Musket Brown
100	Natural Cedar/Cedar*
156	Natural Slate
146	Newport Bay
52	Pebblestone Clay
IB	Portsmouth Blue
170	Quiet Willow
149	Red Brick
ID	Red Cedar
353	Rock Harbor
100	Rugged Canyon
290	Russet Red
18	Sage
39	Sandtone
510	Scottish Thistle
02	Silver Grey
ID	Terra Cotta
E7	Timberstone/Timber*
511	Tuscan Olive
36	Victorian Grey
252	Vineyard Grove
354	Whispering Timber
04	White
A7	Wicker
E4	Woodland Green*
355	Woodland Retreat

\*Recommended solid color match for a variegated color.

# Utility Vents

## Product Code/Description

### DRYERHOOD

#### 4" Hooded Exhaust Vent System

3/4" Siding Receiver  
1" Depth  
Neutral Base  
J-Channel I.D.: 3/4"  
adjusts to 1-1/4"  
1 System/Ctn.  
1 Lb./Ctn.

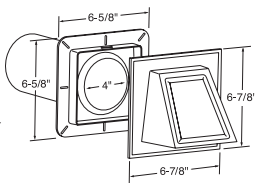

An additional 100 colors are available to match or coordinate with leading siding manufacturer's colors. For additional colors, see "Designer Accents Color Matrix."

### DRYERHOOD6

#### 6" Hooded Exhaust Vent System

3/4" Siding Receiver  
1" Depth  
Neutral Base  
J-Channel I.D.: 3/4"  
adjusts to 1-1/4"  
1 System/Ctn.  
1 Lb./Ctn.

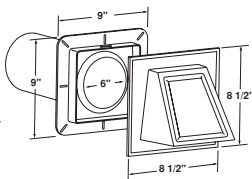

Available with screen. An additional 100 colors are available to match or coordinate with leading siding manufacturer's colors. For additional colors, see "Designer Accents Color Matrix."

### AIRVENT

#### Air Vent

Net Free Area:  
18 square inches  
Surface Dimensions:  
7" x 11"  
Flange Dimensions:  
7-3/4" x 12-3/4"  
J-Channel I.D.: 3/4"  
adjusts to 1-1/4"  
5 Systems/Ctn.  
4 Lbs./Ctn.

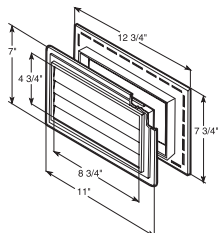

An additional 100 colors are available to match or coordinate with leading siding manufacturer's colors. For additional colors, see "Designer Accents Color Matrix."

## Color Availability

11	Paintable White
53	Almond
350	Alpine Forest
E9	American Walnut/Walnut
EX	Aspen Grey
251	Autumn Harvest
147	Brandy Wood
31	Cameo
36	Cape Cod Grey/Cape Grey
30	Classic Cream
10	Colonial Yellow
210	Corn Silk
352	Deep Cavern
090	Deep Granite
22	Desert Sand
390	English Wedgewood
17	Everest
E6	Glacier Blue
35	Harbor Gray
IC	Lakeshore Fern
44	Linen
148	Mahogany
144	Misty Shadow
IF	Montana Suede
N5	Musket Brown
100	Natural Cedar/Cedar
156	Natural Slate
146	Newport Bay
52	Pebblestone Clay
IB	Portsmouth Blue
170	Quiet Willow
149	Red Brick
ID	Red Cedar
353	Rock Harbor
100	Rugged Canyon
290	Russet Red
18	Sage
39	Sandtone
510	Scottish Thistle
02	Silver Grey
ID	Terra Cotta
E7	Timberstone/Timber
511	Tuscan Olive
36	Victorian Grey
252	Vineyard Grove
354	Whispering Timber
04	White
A7	Wicker
E4	Woodland Green
355	Woodland Retreat

\*Recommended solid color match for a variegated color.

# Utility Vents

## Product Code/Description

EXVENT

### Louvered Exhaust Vent

Surface Dimensions: 7" x 7"

Flange Dimensions: 8-1/2" x 7-1/2"

J-Channel I.D.: 3/4"

adjusts to 1-1/4"

Tube Length: 10"

Tube Diameter: 4"

1 System/Ctn.

1 Lb./Ctn.

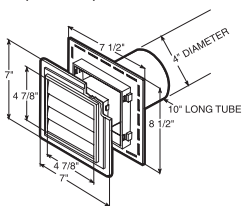

*An additional 100 colors are available to match or coordinate with leading siding manufacturer's colors. For additional colors, see "Designer Accents Color Matrix."*

INTAKE

### Intake Louver (For use with EXVENT)

5 System/Ctn.

1 Lb./Ctn.

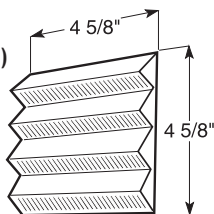

*An additional 100 colors are available to match or coordinate with leading siding manufacturer's colors. For additional colors, see "Designer Accents Color Matrix."*

## Color Availability

11	Paintable White
53	Almond
350	Alpine Forest
E9	American Walnut/Walnut
EX	Aspen Grey
251	Autumn Harvest
147	Brandy Wood
31	Cameo
36	Cape Cod Grey/Cape Grey
30	Classic Cream
10	Colonial Yellow
210	Corn Silk
352	Deep Cavern
090	Deep Granite
22	Desert Sand
390	English Wedgewood
17	Everest
E6	Glacier Blue
35	Harbor Gray
IC	Lakeshore Fern
44	Linen
148	Mahogany
144	Misty Shadow
IF	Montana Suede
N5	Musket Brown
100	Natural Cedar/Cedar
156	Natural Slate
146	Newport Bay
52	Pebblestone Clay
IB	Portsmouth Blue
170	Quiet Willow
149	Red Brick
ID	Red Cedar
353	Rock Harbor
100	Rugged Canyon
290	Russet Red
18	Sage
39	Sandtone
510	Scottish Thistle
02	Silver Grey
ID	Terra Cotta
E7	Timberstone/Timber
511	Tuscan Olive
36	Victorian Grey
252	Vineyard Grove
354	Whispering Timber
04	White
A7	Wicker
E4	Woodland Green
355	Woodland Retreat

*\*Recommended solid color match for a variegated color.*

# Utility Vents

## Product Code/Description

EXVENT6

### 6" Louvered Exhaust Vent

Surface Dimensions: 9" x 9"

Flange Dimensions: 9-1/2" x 10-3/8"

Net Free Area: 17.6 Sq. In.

J-Channel I.D.: 3/4"

adjusts to 1-1/4"

Tube Length: 10"

Tube Diameter: 6"

1 System/Ctn.

1.2 Lb./Ctn.

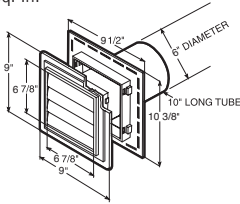

*An additional 100 colors are available to match or coordinate with leading siding manufacturer's colors. For additional colors, see "Designer Accents Color Matrix."*

INTVENT

### Intake/Exhaust Vent

Siding Receiver:

5/8" – 1-1/4"

in 1/8" increments

1 Pc./Ctn.

12.3 Sq. In. Net Free Area

1 Lb./Ctn.

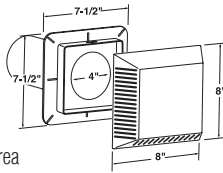

*An additional 100 colors are available to match or coordinate with leading siding manufacturer's colors. For additional colors, see "Designer Accents Color Matrix."*

#### **FIRE HAZARD**

*NEVER use exhaust vent with screen for dryer ventilation. Flammable lint build-up on screen can cause a fire. Always use a vent that is specifically designed for dryer applications.*

## Color Availability

11	Paintable White
53	Almond
350	Alpine Forest
E9	American Walnut/Walnut
EX	Aspen Grey
251	Autumn Harvest
147	Brandy Wood
31	Cameo
36	Cape Cod Grey/Cape Grey
30	Classic Cream
10	Colonial Yellow
210	Corn Silk
352	Deep Cavern
090	Deep Granite
22	Desert Sand
390	English Wedgewood
17	Everest
E6	Glacier Blue
35	Harbor Gray
IC	Lakeshore Fern
44	Linen
148	Mahogany
144	Misty Shadow
IF	Montana Suede
N5	Musket Brown
100	Natural Cedar/Cedar
156	Natural Slate
146	Newport Bay
52	Pebblestone Clay
IB	Portsmouth Blue
170	Quiet Willow
149	Red Brick
ID	Red Cedar
353	Rock Harbor
100	Rugged Canyon
290	Russet Red
18	Sage
39	Sandtone
510	Scottish Thistle
O2	Silver Grey
ID	Terra Cotta
E7	Timberstone/Timber
511	Tuscan Olive
36	Victorian Grey
252	Vineyard Grove
354	Whispering Timber
04	White
A7	Wicker
E4	Woodland Green
355	Woodland Retreat

*\*Recommended solid color match for a variegated color.*

# Utility Vents

## Product Code/Description

### FVENT Foundation Vent

Surface Dimensions:

8-3/4" x 17"

Flange Dimensions:

9-1/2" x 18-1/4"

48 Sq. In. Net Free Area

J-Channel I.D.: 3/4"

adjusts to 1-1/4"

10 Pc./Ctn.

11.94 Lb./Ctn.

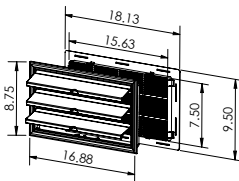

## Color Availability

11	Paintable White
53	Almond
350	Alpine Forest
E9	American Walnut/Walnut*
EX	Aspen Grey*
251	Autumn Harvest
147	Brandy Wood
31	Cameo
36	Cape Cod Grey/Cape Grey*
30	Classic Cream
10	Colonial Yellow
210	Corn Silk
352	Deep Cavern
090	Deep Granite
22	Desert Sand
390	English Wedgewood
17	Everest
E6	Glacier Blue*
35	Harbor Gray
IC	Lakeshore Fern
44	Linen
148	Mahogany
144	Misty Shadow
IF	Montana Suede
N5	Musket Brown
100	Natural Cedar/Cedar*
156	Natural Slate
146	Newport Bay
52	Pebblestone Clay
IB	Portsmouth Blue
170	Quiet Willow
149	Red Brick
ID	Red Cedar
353	Rock Harbor
100	Rugged Canyon
290	Russet Red
18	Sage
39	Sandtone
510	Scottish Thistle
O2	Silver Grey
ID	Terra Cotta
E7	Timberstone/Timber*
511	Tuscan Olive
36	Victorian Grey
252	Vineyard Grove
354	Whispering Timber
O4	White
A7	Wicker
E4	Woodland Green*
355	Woodland Retreat

*\*Recommended solid color match for a variegated color.*

# Gable Vents

## Product Code/Description

RDGV18

### 18" Round Gable Vent

Siding Receiver:  
3/4" – 1-1/4"  
in 1/8" increments  
1 Pc./Ctn.  
48.36 Sq. In.  
Net Free Area  
2.3 Lbs./Ctn.  
1 Pc./Ctn.

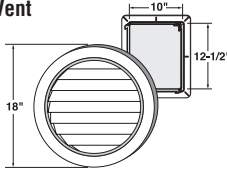

*An additional 100 colors are available to match or coordinate with leading siding manufacturer's colors. For additional colors, see "Designer Accents Color Matrix."*

RDGV

### 22" Round Gable Vent

Siding Receiver:  
3/4" – 1-1/4"  
in 1/8" increments  
Thickness: 1-1/2"  
48.37 Sq. In.  
Net Free Area  
4.1 Lbs./Ctn.  
1 Pc./Ctn.

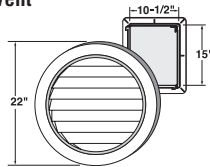

*An additional 100 colors are available to match or coordinate with leading siding manufacturer's colors. For additional colors, see "Designer Accents Color Matrix."*

RDGV36

### 36" Round Gable Vent

Siding Receiver:  
3/4" – 1-1/4"  
in 1/8" increments  
277.1 Sq. In.  
Net Free Area  
8 Lbs./Ctn.  
1 Pc./Ctn.

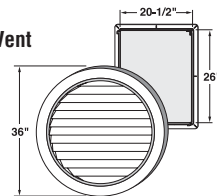

*An additional 100 colors are available to match or coordinate with leading siding manufacturer's colors. For additional colors, see "Designer Accents Color Matrix."*

## Color Availability

11	Paintable White
53	Almond
350	Alpine Forest
E9	American Walnut/Walnut
EX	Aspen Grey
251	Autumn Harvest
147	Brandy Wood
31	Cameo
36	Cape Cod Grey/Cape Grey
30	Classic Cream
10	Colonial Yellow
210	Corn Silk
352	Deep Cavern
090	Deep Granite
22	Desert Sand
390	English Wedgewood
17	Everest
E6	Glacier Blue
35	Harbor Gray
IC	Lakeshore Fern
44	Linen
148	Mahogany
144	Misty Shadow
IF	Montana Suede
N5	Musket Brown
100	Natural Cedar/Cedar
156	Natural Slate
146	Newport Bay
52	Pebblestone Clay
IB	Portsmouth Blue
170	Quiet Willow
149	Red Brick
ID	Red Cedar
353	Rock Harbor
100	Rugged Canyon
290	Russet Red
18	Sage
39	Sandtone
510	Scottish Thistle
02	Silver Grey
ID	Terra Cotta
E7	Timberstone/Timber
511	Tuscan Olive
36	Victorian Grey
252	Vineyard Grove
354	Whispering Timber
04	White
A7	Wicker
E4	Woodland Green
355	Woodland Retreat

*\*Recommended solid color match for a variegated color.*

# Gable Vents

## Product Code/Description

OCTGV18

### 18" Octagon Gable Vent

Siding Receiver:  
3/4" - 1-1/4"  
in 1/8" increments  
49.72 Sq. In.  
Net Free Area  
2.4 Lbs./Ctn.  
1 Pc./Ctn.

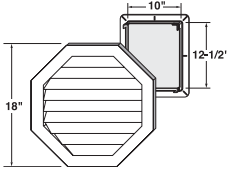

An additional 100 colors are available to match or coordinate with leading siding manufacturer's colors. For additional colors, see "Designer Accents Color Matrix."

OCTGV

### 22" Octagonal Gable Vent

Siding Receiver:  
3/4" - 1-1/4"  
in 1/8" increments  
Thickness: 1-1/2"  
49.5 Sq. In.  
Net Free Area  
5 Lbs./Ctn. 1/Ctn.  
1 Pc./Ctn.

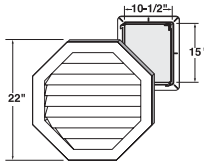

An additional 100 colors are available to match or coordinate with leading siding manufacturer's colors. For additional colors, see "Designer Accents Color Matrix."

HRDGV

### 22" Half Round Gable Vent

Siding Receiver:  
3/4" - 1-1/4"  
in 1/8" increments  
Thickness: 1-1/2"  
80.46 Sq. In.  
Net Free Area  
8 Lbs./Ctn.  
1 Pc./Ctn.

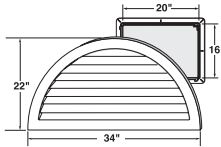

An additional 100 colors are available to match or coordinate with leading siding manufacturer's colors. For additional colors, see "Designer Accents Color Matrix."

## Color Availability

11	Paintable White
53	Almond
350	Alpine Forest
E9	American Walnut/Walnut
EX	Aspen Grey
251	Autumn Harvest
147	Brandy Wood
31	Cameo
36	Cape Cod Grey/Cape Grey
30	Classic Cream
10	Colonial Yellow
210	Corn Silk
352	Deep Cavern
090	Deep Granite
22	Desert Sand
390	English Wedgewood
17	Everest
E6	Glacier Blue
35	Harbor Gray
IC	Lakeshore Fern
44	Linen
148	Mahogany
144	Misty Shadow
IF	Montana Suede
N5	Musket Brown
100	Natural Cedar/Cedar
156	Natural Slate
146	Newport Bay
52	Pebblestone Clay
IB	Portsmouth Blue
170	Quiet Willow
149	Red Brick
ID	Red Cedar
353	Rock Harbor
100	Rugged Canyon
290	Russet Red
18	Sage
39	Sandtone
510	Scottish Thistle
O2	Silver Grey
ID	Terra Cotta
E7	Timberstone/Timber
511	Tuscan Olive
36	Victorian Grey
252	Vineyard Grove
354	Whispering Timber
04	White
A7	Wicker
E4	Woodland Green
355	Woodland Retreat

\*Recommended solid color match for a variegated color.

# Gable Vents

## Product Code/Description

### RDTOPGV14 14" x 22" Round Top Gable Vent

Siding Receiver:  
3/4" – 1-1/4"  
in 1/8" increments  
53.17 Sq. In.  
Net Free Area  
2.7 Lbs./Ctn.  
1 Pc./Ctn.

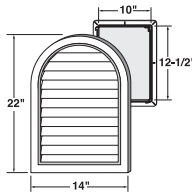

*An additional 100 colors are available to match or coordinate with leading siding manufacturer's colors. For additional colors, see "Designer Accents Color Matrix."*

### RDTOPGV24 24" x 34" Round Top Gable Vent

Siding Receiver:  
3/4" – 1-1/4"  
in 1/8" increments  
191 Sq. In.  
Net Free Area  
6 Lbs./Ctn.  
1 Pc./Ctn.

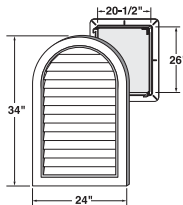

*An additional 100 colors are available to match or coordinate with leading siding manufacturer's colors. For additional colors, see "Designer Accents Color Matrix."*

## Color Availability

11	Paintable White
53	Almond
350	Alpine Forest
E9	American Walnut/Walnut*
EX	Aspen Grey*
251	Autumn Harvest
147	Brandy Wood
31	Cameo
36	Cape Cod Grey/Cape Grey*
30	Classic Cream
10	Colonial Yellow
210	Corn Silk
352	Deep Cavern
090	Deep Granite
22	Desert Sand
390	English Wedgewood
17	Everest
E6	Glacier Blue*
35	Harbor Gray
IC	Lakeshore Fern
44	Linen
148	Mahogany
144	Misty Shadow
IF	Montana Suede
N5	Musket Brown
100	Natural Cedar/Cedar*
156	Natural Slate
146	Newport Bay
52	Pebblestone Clay
IB	Portsmouth Blue
170	Quiet Willow
149	Red Brick
ID	Red Cedar
353	Rock Harbor
100	Rugged Canyon
290	Russet Red
18	Sage
39	Sandtone
510	Scottish Thistle
02	Silver Grey
ID	Terra Cotta
E7	Timberstone*/Timber*
511	Tuscan Olive
36	Victorian Grey
252	Vineyard Grove
354	Whispering Timber
04	White
A7	Wicker
E4	Woodland Green*
355	Woodland Retreat

*\*Recommended solid color match for a variegated color.*

# Gable Vents

## Product Code/Description

SQGV1414

### 14" Square Gable Vent

Siding Receiver:  
3/4" – 1-1/4"  
in 1/8" increments  
Thickness: 1-1/2"  
33.59 Sq. In.  
Net Free Area  
2.3 Lbs./Ctn.  
1 Pc./Ctn.

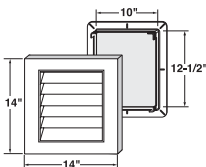

An additional 100 colors are available to match or coordinate with leading siding manufacturer's colors. For additional colors, see "Designer Accents Color Matrix."

RECTGV

### 14" x 20" Rectangular Gable Vent

Siding Receiver:  
3/4" – 1-1/4"  
in 1/8" increments  
Thickness: 1-1/2"  
23.29 Sq. In.  
Net Free Area  
3.83 Lbs./Ctn.  
1 Pc./Ctn.

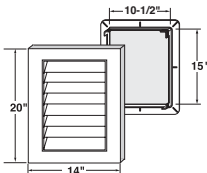

An additional 100 colors are available to match or coordinate with leading siding manufacturer's colors. For additional colors, see "Designer Accents Color Matrix."

## Color Availability

11	Paintable White
53	Almond
350	Alpine Forest
E9	American Walnut/Walnut*
EX	Aspen Grey*
251	Autumn Harvest
147	Brandy Wood
31	Cameo
36	Cape Cod Grey/Cape Grey*
30	Classic Cream
10	Colonial Yellow
210	Corn Silk
352	Deep Cavern
090	Deep Granite
22	Desert Sand
390	English Wedgewood
17	Everest
E6	Glacier Blue*
35	Harbor Gray
IC	Lakeshore Fern
44	Linen
148	Mahogany
144	Misty Shadow
IF	Montana Suede
N5	Musket Brown
100	Natural Cedar/Cedar*
156	Natural Slate
146	Newport Bay
52	Pebblestone Clay
IB	Portsmouth Blue
170	Quiet Willow
149	Red Brick
ID	Red Cedar
353	Rock Harbor
100	Rugged Canyon
290	Russet Red
18	Sage
39	Sandtone
510	Scottish Thistle
02	Silver Grey
ID	Terra Cotta
E7	Timberstone/Timber*
511	Tuscan Olive
36	Victorian Grey
252	Vineyard Grove
354	Whispering Timber
04	White
A7	Wicker
E4	Woodland Green*
355	Woodland Retreat

\*Recommended solid color match for a variegated color.

# Gable Vents

## Product Code/Description

RECTGV1824

### 18" x 24" Rectangular Gable Vent

Siding Receiver:  
3/4" – 1-1/4"  
in 1/8" increments  
Thickness: 1-1/2"  
92.88 Sq. In.  
Net Free Area  
5.68 Lbs./Ctn.  
1 Pc./Ctn.

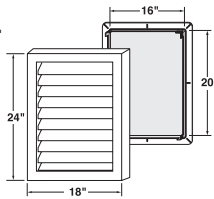

*An additional 100 colors are available to match or coordinate with leading siding manufacturer's colors. For additional colors, see "Designer Accents Color Matrix."*

RECTGV2430

### 24" x 30" Rectangular Gable Vent

Siding Receiver:  
3/4" – 1-1/4"  
in 1/8" increments  
Thickness: 1-1/2"  
181.2 Sq. In.  
Net Free Area  
9 Lbs./Ctn.  
1 Pc./Ctn.

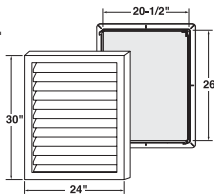

*An additional 100 colors are available to match or coordinate with leading siding manufacturer's colors. For additional colors, see "Designer Accents Color Matrix."*

## Color Availability

11	Paintable White
53	Almond
350	Alpine Forest
E9	American Walnut/Walnut
EX	Aspen Grey
251	Autumn Harvest
147	Brandy Wood
31	Cameo
36	Cape Cod Grey/Cape Grey
30	Classic Cream
10	Colonial Yellow
210	Corn Silk
352	Deep Cavern
090	Deep Granite
22	Desert Sand
390	English Wedgewood
17	Everest
E6	Glacier Blue
35	Harbor Gray
IC	Lakeshore Fern
44	Linen
148	Mahogany
144	Misty Shadow
IF	Montana Suede
N5	Musket Brown
100	Natural Cedar/Cedar
156	Natural Slate
146	Newport Bay
52	Pebblestone Clay
IB	Portsmouth Blue
170	Quiet Willow
149	Red Brick
ID	Red Cedar
353	Rock Harbor
100	Rugged Canyon
290	Russet Red
18	Sage
39	Sandtone
510	Scottish Thistle
02	Silver Grey
ID	Terra Cotta
E7	Timberstone/Timber
511	Tuscan Olive
36	Victorian Grey
252	Vineyard Grove
354	Whispering Timber
04	White
A7	Wicker
E4	Woodland Green
355	Woodland Retreat

*\*Recommended solid color match for a variegated color.*

# Designer Accents Color Matrix for Vinyl Siding Manufacturers

Manufacturer	Code	Color
PLY GEM SIDING PERFORMANCE COLLECTION	53	Almond
PLY GEM SIDING PERFORMANCE COLLECTION	IG	Alpine Green
PLY GEM SIDING PERFORMANCE COLLECTION	39	Autumn Tan
PLY GEM SIDING PERFORMANCE COLLECTION	30	Beige
PLY GEM SIDING PERFORMANCE COLLECTION	803	Brownstone
PLY GEM SIDING PERFORMANCE COLLECTION	812	Brunswick
PLY GEM SIDING PERFORMANCE COLLECTION	100	Canyon
PLY GEM SIDING PERFORMANCE COLLECTION	E9	Chestnut*
PLY GEM SIDING PERFORMANCE COLLECTION	802	Cinnabar
PLY GEM SIDING PERFORMANCE COLLECTION	813	Dublin
PLY GEM SIDING PERFORMANCE COLLECTION	210	French Silk
PLY GEM SIDING PERFORMANCE COLLECTION	090	Granite
PLY GEM SIDING PERFORMANCE COLLECTION	E7	Hickory*
PLY GEM SIDING PERFORMANCE COLLECTION	814	Iron
PLY GEM SIDING PERFORMANCE COLLECTION	31	Ivory
PLY GEM SIDING PERFORMANCE COLLECTION	E4	Juniper*
PLY GEM SIDING PERFORMANCE COLLECTION	52	Khaki
PLY GEM SIDING PERFORMANCE COLLECTION	18	Mist
PLY GEM SIDING PERFORMANCE COLLECTION	N5	Musket Brown
PLY GEM SIDING PERFORMANCE COLLECTION	35	Nantucket Gray
PLY GEM SIDING PERFORMANCE COLLECTION	511	Olive
PLY GEM SIDING PERFORMANCE COLLECTION	IB	Patriot Blue
PLY GEM SIDING PERFORMANCE COLLECTION	36	Pewter
PLY GEM SIDING PERFORMANCE COLLECTION	290	Russet Red
PLY GEM SIDING PERFORMANCE COLLECTION	22	Sand
PLY GEM SIDING PERFORMANCE COLLECTION	144	Shadow
PLY GEM SIDING PERFORMANCE COLLECTION	17	Slate Blue
PLY GEM SIDING PERFORMANCE COLLECTION	E6	Spruce Blue*
PLY GEM SIDING PERFORMANCE COLLECTION	02	Stone Gray
PLY GEM SIDING PERFORMANCE COLLECTION	IF	Suede
PLY GEM SIDING PERFORMANCE COLLECTION	10	Sunrise Yellow
PLY GEM SIDING PERFORMANCE COLLECTION	510	Thistle
PLY GEM SIDING PERFORMANCE COLLECTION	52	Weathered Ash*
PLY GEM SIDING PERFORMANCE COLLECTION	390	Wedgewood
PLY GEM SIDING PERFORMANCE COLLECTION	04	White
PLY GEM SIDING PERFORMANCE COLLECTION	A7	Wicker
PLY GEM SIDING PERFORMANCE COLLECTION	170	Willow
ABTCO	ET	Almond
ABTCO	FL	Antique Ivory
ABTCO	GJ	Brick
ABTCO	090	Charcoal
ABTCO	S7	Cherry*

# Designer Accents Color Matrix for Vinyl Siding Manufacturers

Manufacturer	Code	Color
ABTCO	44	Classic Linen
ABTCO	EY	Clay
ABTCO	T8	Cobalt
ABTCO	FP	Cobblestone
ABTCO	DD	Cypress*
ABTCO	GM	Evergreen
ABTCO	FM	Gray
ABTCO	02	Heritage Gray
ABTCO	52	Khaki
ABTCO	BM	Natural Oak*
ABTCO	100	Pecan
ABTCO	30	Prairie Wheat
ABTCO	GI	River Rock*
ABTCO	JE	Sage
ABTCO	EX	Sand
ABTCO	22	Sandstone
ABTCO	FN	Slate
ABTCO	46	Slate Blue
ABTCO	39	Tan
ABTCO	148 or G0	Umber
ABTCO	JC	Vermont Maple*
ABTCO	EJ	Weathered Wood*
ABTCO	04	White
ALSIDE	EV	Adobe Cream
ALSIDE	80	Ageless Slate
ALSIDE	PP	Antique Parchment
ALSIDE	IF	Canyon Drift / Hawthorne*
ALSIDE	EJ	Cape Cod Gray
ALSIDE	144	Charcoal Smoke
ALSIDE	510	Coastal Sage
ALSIDE	813	Deep Moss
ALSIDE	No Closest Match	Fired Brick
ALSIDE	No Closest Match	Flagship Brown
ALSIDE	PW	Glacier White
ALSIDE	No Closest Match	Harbor Blue
ALSIDE	JE	Juniper Ridge
ALSIDE	JD	Maple
ALSIDE	RD	Midnight Blue
ALSIDE	22	Monterey Sand
ALSIDE	QL	Mountain Fern

*\*Recommended solid color match for a variegated color*

# Designer Accents Color Matrix for Vinyl Siding Manufacturers

Manufacturer	Code	Color
ALSIDE	ND	Mystic Blue
ALSIDE	44	Natural Linen
ALSIDE	EH	Platinum Gray
ALSIDE	090	Sterling Gray
ALSIDE	EA	Storm
ALSIDE	52	Tuscan Clay
ALSIDE	A7	Vintage Wicker
AMCRAFT	53	Almond
AMCRAFT	30	Classic Cream
AMCRAFT	090	Deep Granite
AMCRAFT	390	English Wedgewood
AMCRAFT	52	Pebblestone Clay
AMCRAFT	170	Quiet Willow
AMCRAFT	100	Rugged Canyon
AMCRAFT	510	Scottish Thistle
AMCRAFT	02	Silver Grey
AMCRAFT	36	Victorian Grey
AMCRAFT	04	White
AMCRAFT	A7	Wicker
CERTAINTED	BH	Arbor Blend*
CERTAINTED	090	Artic Blend*
CERTAINTED	802	Autumn Red
CERTAINTED	10	Autumn Yellow
CERTAINTED	No Close Match	Bermuda Blue
CERTAINTED	G0	Brownstone
CERTAINTED	254	Buckskin
CERTAINTED	FP	Canyon Blend
CERTAINTED	EA	Castle Stone
CERTAINTED	E6	Charcoal Gray
CERTAINTED	PW	Colonial White
CERTAINTED	JE	Cypress
CERTAINTED	53	Desert Tan
CERTAINTED	803	Espresso
CERTAINTED	BU	Flagstone
CERTAINTED	GM	Forest
CERTAINTED	E3	Frontier Blend*
CERTAINTED	36	Glacier Blend*
CERTAINTED	35	Granite Gray
CERTAINTED	No Close Match	Green Tea
CERTAINTED	DDM	Hearthstone
CERTAINTED	30	Heritage Cream

# Designer Accents Color Matrix for Vinyl Siding Manufacturers

Manufacturer	Code	Color
CERTAINEED	C3	Herringbone
CERTAINEED	ET	Light Maple
CERTAINEED	BM	Meadow Blend*
CERTAINEED	AL	Melrose
CERTAINEED	146	Midnight Blue
CERTAINEED	SP	Mountain Cedar
CERTAINEED	PC	Natural Clay
CERTAINEED	EC	Oxford Blue
CERTAINEED	T8	Pacific Blue
CERTAINEED	BQ	Sable Brown
CERTAINEED	EM	Sandstone Beige
CERTAINEED	A7	Savannah Wicker
CERTAINEED	510	Seagrass
CERTAINEED	BM	Silver Ash
CERTAINEED	355	Slate
CERTAINEED	SS	Spruce
CERTAINEED	A4	Sterling Gray
CERTAINEED	SQ	Suede
CERTAINEED	ID	Terra Cotta
CERTAINEED	100	Timber Blend*
CERTAINEED	JH	Weathered Blend*
EXTERIOR PORTFOLIO	04	Aspen White
EXTERIOR PORTFOLIO	BI	Bone
EXTERIOR PORTFOLIO	IF	Canyon
EXTERIOR PORTFOLIO	QV	Carbon
EXTERIOR PORTFOLIO	52	Clay
EXTERIOR PORTFOLIO	FJ	Country Beige
EXTERIOR PORTFOLIO	GP	Cypress
EXTERIOR PORTFOLIO	A4	Driftwood
EXTERIOR PORTFOLIO	BQ	Espresso
EXTERIOR PORTFOLIO	RE	Graphite
EXTERIOR PORTFOLIO	EW	Greystone
EXTERIOR PORTFOLIO	254	Honey Oak
EXTERIOR PORTFOLIO	353	Indigo
EXTERIOR PORTFOLIO	290	Lighthouse Red
EXTERIOR PORTFOLIO	090	Metropolitan Gray
EXTERIOR PORTFOLIO	22	Mocha
EXTERIOR PORTFOLIO	GI	Nantucket
EXTERIOR PORTFOLIO	BU	Oceanside
EXTERIOR PORTFOLIO	IC	Olive
EXTERIOR PORTFOLIO	31	Pearl
EXTERIOR PORTFOLIO	355	Peppercorn

\*Recommended solid color match for a variegated color

# Designer Accents Color Matrix for Vinyl Siding Manufacturers

Manufacturer	Code	Color
EXTERIOR PORTFOLIO	ND	Polaris
EXTERIOR PORTFOLIO	146 or LA	Regatta
EXTERIOR PORTFOLIO	EY	Rye
EXTERIOR PORTFOLIO	39	Saddle
EXTERIOR PORTFOLIO	156 or RD	Slate
EXTERIOR PORTFOLIO	63	Wheat
FOUNDRY	BF	Aged Chestnut*
FOUNDRY	EV	Almond
FOUNDRY	EN	Antique Cream*
FOUNDRY	39	Biscuit
FOUNDRY	No Close Match	Blueberry
FOUNDRY	PD	Butter Pecan*
FOUNDRY	EN	Classic Sand*
FOUNDRY	E7	Cocoa
FOUNDRY	EM	Coconut
FOUNDRY	EN	Cottonwood*
FOUNDRY	E0	Driftwood
FOUNDRY	31	Eggshell
FOUNDRY	PC	Harvest Wheat*
FOUNDRY	JA	Honey Brown*
FOUNDRY	JF	Juniper
FOUNDRY	RG	Keylime
FOUNDRY	LW	Lemonade
FOUNDRY	02	Moonlight
FOUNDRY	510	Moss
FOUNDRY	FP	Oatmeal
FOUNDRY	No Close Match	Oceanside
FOUNDRY	RP	Papaya
FOUNDRY	53	Putty
FOUNDRY	GJ	Russet
FOUNDRY	E9	Rustic Brown
FOUNDRY	22	Sahara
FOUNDRY	PC	Sandalwood*
FOUNDRY	C3	Seashell
FOUNDRY	E1	Seaside Grey*
FOUNDRY	52	Shadow
FOUNDRY	BL	Shale
FOUNDRY	36	Slate
FOUNDRY	PW	Snow
FOUNDRY	EN	Toasted Almond*
FOUNDRY	PC	Toffee

# Designer Accents Color Matrix for Vinyl Siding Manufacturers

Manufacturer	Code	Color
FOUNDRY	EN	Vanilla Bean*
FOUNDRY	BN	Vintage Green*
FOUNDRY	E4	Vintage Taupe*
GENTEK/REVERE	53	Almond
GENTEK/REVERE	39	Antique Ivory
GENTEK/REVERE	JA	Brownstone
GENTEK/REVERE	EY	Canyon Clay
GENTEK/REVERE	JH	Classic Brown
GENTEK/REVERE	100	Dark Drift
GENTEK/REVERE	X4	Dover Gray
GENTEK/REVERE	GB	Harvest Wheat
GENTEK/REVERE	44	Linen
GENTEK/REVERE	30	Maize
GENTEK/REVERE	156 or RD	Midnight Surf
GENTEK/REVERE	46	Mist Blue
GENTEK/REVERE	GM	Moonlit Moss
GENTEK/REVERE	52	Norwood
GENTEK/REVERE	02	Pearl
GENTEK/REVERE	PC	Pebble
GENTEK/REVERE	RF	Saddle Brown
GENTEK/REVERE	BZ	Sage
GENTEK/REVERE	EX	Sandalwood
GENTEK/REVERE	31	Sandstone
GENTEK/REVERE	EM	Sandstone
GENTEK/REVERE	PW	Snow White
GENTEK/REVERE	290	Venetian Red
GENTEK/REVERE	A7	Wicker
GENTEK/REVERE	RE	Windswept Smoke
GEORGIA-PACIFIC	53	Almond
GEORGIA-PACIFIC	254	Amber
GEORGIA-PACIFIC	145	Bayou
GEORGIA-PACIFIC	EX	Beige
GEORGIA-PACIFIC	BK	Blue
GEORGIA-PACIFIC	100	Briarwood
GEORGIA-PACIFIC	PC	Clay
GEORGIA-PACIFIC	090	Coastal Blue*
GEORGIA-PACIFIC	30	Cream
GEORGIA-PACIFIC	ED	Flint
GEORGIA-PACIFIC	02	Gray
GEORGIA-PACIFIC	290	Hampton Red
GEORGIA-PACIFIC	260	Hazelnut
GEORGIA-PACIFIC	BQ	Hearthstone Brown*

\*Recommended solid color match for a variegated color

# Designer Accents Color Matrix for Vinyl Siding Manufacturers

Manufacturer	Code	Color
GEORGIA-PACIFIC	BI	Mist
GEORGIA-PACIFIC	N5	Musket Brown
GEORGIA-PACIFIC	PC	Northern Oak*
GEORGIA-PACIFIC	511	Olive
GEORGIA-PACIFIC	IC	Palm
GEORGIA-PACIFIC	PP	Pearl
GEORGIA-PACIFIC	090	Pewter
GEORGIA-PACIFIC	ID	Redwood*
GEORGIA-PACIFIC	170	Sagebrook
GEORGIA-PACIFIC	100	Shaded Cedar*
GEORGIA-PACIFIC	ED	Shaded Gray*
GEORGIA-PACIFIC	144	Shadow
GEORGIA-PACIFIC	A7	Tan
GEORGIA-PACIFIC	IF	Teak
GEORGIA-PACIFIC	510	Thistle
GEORGIA-PACIFIC	390	Wedgewood
GEORGIA-PACIFIC	PW	White
ProVia	C3	Antique White
ProVia	170	Aspen
ProVia	31	Birchwood
ProVia	254	Camel
ProVia	100	Canyon
ProVia	EN	Chateau
ProVia	PC	Clay
ProVia	EV	Cream
ProVia	N5	Deep Brown
ProVia	FN	Everest
ProVia	090	Granite
ProVia	A4	Gray
ProVia	QU	Harvest Wheat
ProVia	FK	Hero Blue
ProVia	HL	Linin
ProVia	E3	Mocha
ProVia	No Close Match	Mountain Berry
ProVia	LY	Nautica
ProVia	ED	Pewter
ProVia	511	Prairie
ProVia	GV	Premium Blue
ProVia	JE	Sage
ProVia	22	Sand
ProVia	JP	Sandalwood

# Designer Accents Color Matrix for Vinyl Siding Manufacturers

Manufacturer	Code	Color
ProVia	BF	Sandpiper
ProVia	RD	Sea Slate
ProVia	S1 or 18	Sienna
ProVia	JK	Stone
ProVia	144	Timberline
ProVia	PW	White
ProVia	QP	Willow
JAMES HARDIE	BH	Aged Pewter
JAMES HARDIE	04	Arctic White
JAMES HARDIE	EN	Autumn Tan
JAMES HARDIE	390	Boothbay Blue
JAMES HARDIE	RF	Chestnut Brown
JAMES HARDIE	C3	Cobble Stone
JAMES HARDIE	GJ	Countrylane Red
JAMES HARDIE	LA	Deep Ocean
JAMES HARDIE	156 or RD	Evening Blue
JAMES HARDIE	GI	Gray Slate
JAMES HARDIE	QU	Harris Cream
JAMES HARDIE	JE	Heathered Moss
JAMES HARDIE	QV	Iron Gray
JAMES HARDIE	JL	Khaki Brown
JAMES HARDIE	X4	Light Mist
JAMES HARDIE	BE	Monterey Taupe
JAMES HARDIE	SS	Mountain Sage
JAMES HARDIE	53	Navajo Beige
JAMES HARDIE	BU	Night Gray
JAMES HARDIE	QW	Parkside Pine
JAMES HARDIE	36	Pearl Gray
JAMES HARDIE	RE	Rich Espresso
JAMES HARDIE	EV	Sail Cloth
JAMES HARDIE	BF	Sandstone Beige
JAMES HARDIE	18	Soft Green
JAMES HARDIE	E4	Timber Bark
JAMES HARDIE	IA	Tuscan Gold
JAMES HARDIE	10	Woodland Cream
JAMES HARDIE	DD	Woodstock Brown
KAYCAN	BK	Azure Blue
KAYCAN	22	Bisque
KAYCAN	EY	Clay
KAYCAN	FN	Flagstone
KAYCAN	30	Ivory
KAYCAN	JA	Khaki

# Designer Accents Color Matrix for Vinyl Siding Manufacturers

Manufacturer	Code	Color
KAYCAN	C3	Linen White
KAYCAN	EX	Mocha
KAYCAN	22	Pebblestone
KAYCAN	E0	Prestige Beige
KAYCAN	BM	Quartz
KAYCAN	510	Sage
KAYCAN	53	Sandalwood
KAYCAN	36	Slate Gray
KAYCAN	BT	Terra Verde
KAYCAN	04	White
KP BUILDING PRODUCTS	ET	Almond
KP BUILDING PRODUCTS	30	Antique Ivory
KP BUILDING PRODUCTS	GJ	Barn Red
KP BUILDING PRODUCTS	EP	Blue Mist
KP BUILDING PRODUCTS	GK	Camel
KP BUILDING PRODUCTS	A7	Canvas
KP BUILDING PRODUCTS	S7	Cherry
KP BUILDING PRODUCTS	44	Classic Linen
KP BUILDING PRODUCTS	EY	Clay
KP BUILDING PRODUCTS	FP	Cobblestone
KP BUILDING PRODUCTS	31	Cream
KP BUILDING PRODUCTS	52	Cypress
KP BUILDING PRODUCTS	J9	Dusk
KP BUILDING PRODUCTS	GM	Forest
KP BUILDING PRODUCTS	30	French Vanilla
KP BUILDING PRODUCTS	EW	Graphite
KP BUILDING PRODUCTS	FM	Gray
KP BUILDING PRODUCTS	02	Heritage Gray
KP BUILDING PRODUCTS	JA	Khaki
KP BUILDING PRODUCTS	148 or G0	Mahogany
KP BUILDING PRODUCTS	S1	Meadow
KP BUILDING PRODUCTS	BM	Natural Oak
KP BUILDING PRODUCTS	T8	Ocean
KP BUILDING PRODUCTS	22	Pine
KP BUILDING PRODUCTS	30	Prairie Wheat*
KP BUILDING PRODUCTS	53	Putty
KP BUILDING PRODUCTS	17	River Rock
KP BUILDING PRODUCTS	GP	Sage
KP BUILDING PRODUCTS	EX	Sand
KP BUILDING PRODUCTS	22	Sandstone
KP BUILDING PRODUCTS	FN	Slate
KP BUILDING PRODUCTS	EI	Smoke

# Designer Accents Color Matrix for Vinyl Siding Manufacturers

Manufacturer	Code	Color
KP BUILDING PRODUCTS	GQ	Spice
KP BUILDING PRODUCTS	100	Suede
KP BUILDING PRODUCTS	39	Tan
KP BUILDING PRODUCTS	39	Vermont Maple
KP BUILDING PRODUCTS	BM	Weathered Wood*
MASTIC	04	White
MASTIC	53	Almond
MASTIC	350	Alpine Forest
MASTIC	E9	American Walnut*/Walnut*
MASTIC	EX	Aspen Grey*
MASTIC	251	Autumn Harvest
MASTIC	147	Brandy Wood
MASTIC	31	Cameo
MASTIC	36	Cape Cod Grey*/Cape Grey*
MASTIC	80	Charcoal Grey
MASTIC	30	Classic Cream
MASTIC	10	Colonial Yellow
MASTIC	210	Corn Silk
MASTIC	JS	Dark Bronze
MASTIC	352	Deep Cavern
MASTIC	090	Deep Granite
MASTIC	22	Desert Sand
MASTIC	390	English Wedgewood
MASTIC	17	Everest
MASTIC	E6	Glacier Blue*
MASTIC	35	Harbor Gray
MASTIC	IC	Lakeshore Fern
MASTIC	44	Linen
MASTIC	148	Mahogany
MASTIC	144	Misty Shadow
MASTIC	IF	Montana Suede
MASTIC	N5	Musket Brown
MASTIC	100	Natural Cedar*/Cedar*
MASTIC	156	Natural Slate
MASTIC	146	Newport Bay
MASTIC	52	Pebblestone Clay
MASTIC	IB	Portsmouth Blue
MASTIC	170	Quiet Willow
MASTIC	149	Red Brick
MASTIC	ID	Red Cedar*
MASTIC	353	Rock Harbor
MASTIC	100	Rugged Canyon

\*Recommended solid color match for a variegated color

# Designer Accents Color Matrix for Vinyl Siding Manufacturers

Manufacturer	Code	Color
MASTIC	290	Russet Red
MASTIC	18	Sage
MASTIC	39	Sandtone
MASTIC	510	Scottish Thistle
MASTIC	02	Silver Grey
MASTIC	ID	Terra Cotta
MASTIC	E7	Timberstone*/Timber*
MASTIC	511	Tuscan Olive
MASTIC	36	Victorian Grey
MASTIC	252	Vineyard Grove
MASTIC	354	Whispering Timber
MASTIC	04	White
MASTIC	A7	Wicker
MASTIC	E4	Woodland Green*
MASTIC	355	Woodland Retreat
MITTEN	No Close Match	Annapolis Blue
MITTEN	No Close Match	Artic Grey
MITTEN	E8	Ash
MITTEN	QL	Aviator Green
MITTEN	PP	Bone
MITTEN	PC	Brownstone
MITTEN	QM	Burnt Orange
MITTEN	No Close Match	Burnt Sienna
MITTEN	RF	Caribou Brown
MITTEN	G0	Chestnut Brown
MITTEN	511	Clay
MITTEN	803	Coffee Bean
MITTEN	JE	Cypress
MITTEN	Q1	Danish Gold
MITTEN	N5	Eggplant
MITTEN	E7	Farmhouse
MITTEN	36	Flagstone
MITTEN	04M	Frost
MITTEN	QP	Grenadier Green
MITTEN	QY	Gunmetal Grey
MITTEN	FP	Hearthstone
MITTEN	BH	Hemlock
MITTEN	390	Indigo
MITTEN	EZ	Ivory
MITTEN	DDM	Khaki Brown

# Designer Accents Color Matrix for Vinyl Siding Manufacturers

Manufacturer	Code	Color
MITTEN	290	Lighthouse Red
MITTEN	JD	Lite Maple
MITTEN	ICM	Muskoka Green
MITTEN	NKL	Nickel
MITTEN	QX	Regatta Blue
MITTEN	GJ	Richmond Red
MITTEN	144	Rockaway Grey
MITTEN	QR	Saffron
MITTEN	EI	Sage
MITTEN	JP	Sandalwood
MITTEN	22	Sandcastle
MITTEN	156	Sapphire Blue
MITTEN	FM	Satin Grey
MITTEN	QT	Spring Moss
MITTEN	EA	Stratus
MITTEN	E4M	Timber Bark
NAPCO	260	American Hazelnut
NAPCO	145	Blue Bayou
NAPCO	EX	Canyon Beige
NAPCO	FK	Cape Blue
NAPCO	39	Catalina Sandtone
NAPCO	511	Cordoba Olive
NAPCO	EZ	Country Cream
NAPCO	510	Desert Cactus
NAPCO	144	Evening Shadow
NAPCO	ED	Fieldstone Flint
NAPCO	HL	Heritage Linen
NAPCO	66	Herringbone Mist
NAPCO	IC	Island Palm
NAPCO	02	Lakeshore Gray
NAPCO	PW	Liberty White
NAPCO	53	Monterey Almond
NAPCO	100	Mountain Briarwood
NAPCO	N5	Musket Brown
NAPCO	090	Nantucket Pewter
NAPCO	390	Olde Town Wedgewood
NAPCO	IF	Plantation Teak
NAPCO	22	Rich Mocha
NAPCO	290	Sedona Red
NAPCO	100	Shaded Cedar*
NAPCO	ED	Shaded Gray*
NAPCO	170	Southwest Sagebrook

\*Recommended solid color match for a variegated color

# Designer Accents Color Matrix for Vinyl Siding Manufacturers

Manufacturer	Code	Color
NAPCO	PC	Stone Clay
NAPCO	254	Sunset Amber
NAPCO	A7	Wheatfield Tan
NORANDEX	EE or 53	Almond
NORANDEX	31	Beige
NORANDEX	BZ	Cactus
NORANDEX	QV	Carbon
NORANDEX	BI	Champagne
NORANDEX	36	Colonial Grey
NORANDEX	EV or 30	Cream
NORANDEX	RD	Deep Water
NORANDEX	FN	Dove Gray
NORANDEX	JF	Evergreen
NORANDEX	BZ	Fern
NORANDEX	290	Firebrick
NORANDEX	390	Geneva Blue
NORANDEX	GI	Granite
NORANDEX	144	Graphite
NORANDEX	J6	Ivy
NORANDEX	QT	Khaki
NORANDEX	HL	Linen
NORANDEX	BQ	Maverick Brown
NORANDEX	52	Mocha
NORANDEX	QN	Musket Brown
NORANDEX	813	Myrtle
NORANDEX	GP	Olive
NORANDEX	COC	Royal Brown
NORANDEX	100	Russet
NORANDEX	FP	Sand / Tumbleweed
NORANDEX	BF	Sandstone
NORANDEX	BU	Seaport
NORANDEX	52	Sierra
NORANDEX	02	Silver
NORANDEX	EA	Smoke
NORANDEX	T8	Steel Blue
NORANDEX	53	Tan
NORANDEX	63	Tumbleweed
NORANDEX	ND	Wedgewood
NORANDEX	EN	Wheat
NORANDEX	PW	White
NORANDEX	10	Yellow

# Designer Accents Color Matrix for Vinyl Siding Manufacturers

Manufacturer	Code	Color
RMC	52	Adobe Clay
RMC	BM	Autumn Taupe
RMC	IF	Canyon Brown
RMC	EA	Charcoal Grey
RMC	EE	Classic Sand
RMC	RG	Concord Green
RMC	D2	Countryside Green
RMC	O2	Dove Gray
RMC	PW	Frost White
RMC	T8	Hampton Blue
RMC	A4	Harbor Stone
RMC	E9	Harvest Brown*
RMC	GJ	Heritage Red
RMC	44	Linen
RMC	10	Providence Yellow
RMC	BE	Soft Heather
RMC	49	Summer Wheat
RMC	30	Sunny Maize
RMC	BL	Terra Clay
RMC	ED	Timber Wolfe*
RMC	46	Victorian Slate
RMC	BZ	Vintage Sage
RMC	22	Warm Sandalwood
RMC	GM	Whispering Pine*
RMC	04	White Birch
RMC	BF	Wicker Beige
ROYAL	BRK	Bark
ROYAL	30	Beige
ROYAL	146 or LA	Blue
ROYAL	GV	Blue Grey
ROYAL	No Close Match	Blue Spruce*
ROYAL	49	Champagne
ROYAL	BU	Charcoal Gray
ROYAL	GG	Chesapeake Green
ROYAL	EY	Clay
ROYAL	COC	Cocoa
ROYAL	D2	Country Green
ROYAL	JE	Cypress
ROYAL	C3	Driftwood
ROYAL	RE	Espresso
ROYAL	510	Flagstone
ROYAL	X4	Gray

\*Recommended solid color match for a variegated color

# Designer Accents Color Matrix for Vinyl Siding Manufacturers

Manufacturer	Code	Color
ROYAL	RE	Granite
ROYAL	RG	Green
ROYAL	390	Hampton Blue
ROYAL	EA	Harvard Slate
ROYAL	E0	Heather
ROYAL	E9	Highland Cedar*
ROYAL	IA	Honey Oak
ROYAL	IST	Ironstone
ROYAL	HL	Linen
ROYAL	BH	Meadow Green*
ROYAL	T8	Midnight Surf
ROYAL	BK	Mountain Blue
ROYAL	RF	Natural Cedar
ROYAL	52	Pebble Clay
ROYAL	GJ	Red Cedar*
ROYAL	290	Redwood
ROYAL	290	Rustic Red
ROYAL	EI	Sage
ROYAL	22	Sand
ROYAL	GM	Shamrock
ROYAL	ET	Soft Maple
ROYAL	BI	Sterling
ROYAL	M0	Sunflower
ROYAL	36	Victorian Gray
ROYAL	EV	Vintage Cream
ROYAL	100	Walnut
ROYAL	WGD	Wedgewood
ROYAL	PW	White
ROYAL	A7	Wicker
ROYAL	10	Yellow
VARIFORM	FQ	Adirondack Oak*
VARIFORM	254	Amber
VARIFORM	BQ	Appalachian Chestnut*
VARIFORM	EX	Autumn Beige
VARIFORM	145	Bayou
VARIFORM	100	Briarwood
VARIFORM	100	Cabin Cedar*
VARIFORM	100	Catskill Maple*
VARIFORM	30	Classic Cream
VARIFORM	090	Coastal Blue
VARIFORM	ED	Cottage Gray*
VARIFORM	63	Delray Sand

# Designer Accents Color Matrix for Vinyl Siding Manufacturers

Manufacturer	Code	Color
VARIFORM	PW	Dover White
VARIFORM	ED	Flint
VARIFORM	02	Georgian Gray
VARIFORM	260	Hazelnut
VARIFORM	BQ	Hearthstone Brown
VARIFORM	510	Irish Thistle
VARIFORM	090	Ironwood*
VARIFORM	PP	Island Pearl
VARIFORM	IC	Mediterranean Palm
VARIFORM	S7	Mesabi Cherry*
VARIFORM	N5	Musket Brown
VARIFORM	53	Natural Almond
VARIFORM	PC	Northern Oak
VARIFORM	090	Pewter
VARIFORM	ID	Redwood
VARIFORM	170	Sagebrook
VARIFORM	39	Sandtone
VARIFORM	A7	Sandy Tan
VARIFORM	BK	Savannah Blue
VARIFORM	290	Sedona Red
VARIFORM	170	Sierra Mesquite*
VARIFORM	BI	Silver Mist
VARIFORM	511	Spanish Olive
VARIFORM	PC	Stone Mountain Clay
VARIFORM	090	Sycamore*
VARIFORM	IF	Teak
VARIFORM	144	Twilight Shadow
VARIFORM	390	Wedgewood
VYTEC	30	Antique Ivory
VYTEC	BM	Autumn Ash
VYTEC	E4	Autumn Leaf
VYTEC	10	California Coast
VYTEC	DD	Castle Ridge
VYTEC	PC	Clay
VYTEC	02	Clipper Gray
VYTEC	49	Country Almond
VYTEC	N5	Dark Brown
VYTEC	53	Desert
VYTEC	BI	Driftwood
VYTEC	36	Estate Gray
VYTEC	GM	Forest
VYTEC	156 or RD	Harbor

\*Recommended solid color match for a variegated color

# Designer Accents Color Matrix for Vinyl Siding Manufacturers

Manufacturer	Code	Color
VYTEC	EP	Horizon Blue
VYTEC	31	Irish Linen
VYTEC	390	Lakeshore Blue
VYTEC	GJ	Redwood
VYTEC	BN	Sage Green
VYTEC	PC	Sand
VYTEC	100	Shoreline
VYTEC	FJ	Sierra Brown
VYTEC	RE	Smokestone
VYTEC	EA	Storm
VYTEC	510	Tundra Moss
VYTEC	FN	Twilight Gray
VYTEC	PW	White

# Trim Sheet

## Mastic Colors

Product Code/Description	Color Code	Color on Front	Color on Back
TS24	04	White	White
<b>Smooth</b>	53	Almond	White
<b>24" Trim Sheet</b>	350	Alpine Forest	White
(Coated two sides)	E9	American Walnut	White
Finish: Alumalure 2000®	E8	Aspen Grey	White
Nominal .019 Thick	251	Autumn Harvest	White
Length: 50'	33	Black	White
1 Roll/Ctn.	147	Brandy Wood	White
25 Lbs./Ctn.	803	Brownstone	White
<i>Note: All colors are solid</i>	812	Brunswick	White
	31	Cameo	White
	36	Cape Cod Grey	White
	80	Charcoal Grey	White
	802	Cinnabar	White
	30	Classic Cream	White
	10	Colonial Yellow	White
	135	Copper Penny	White
	210	Corn Silk	White
	JS	Dark Bronze	White
	352	Deep Cavern	White
	090	Deep Granite	White
	22	Desert Sand	White
	813	Dublin	White
	390	English Wedgewood	White
	17	Everest	White
	70	Evergreen	White
	E6	Glacier Blue	White
	35	Harbor Grey	White
	IG	Hazelwood	White
	814	Iron	White
	AO	Jefferson Tan	White
	IC	Lakeshore Fern	White
	44	Linen	White
	JN	London Brown	White
	148	Mahogany	White
	144	Misty Shadow	White
	IF	Montana Suede	White
	59	Musket Brown	White
	52	Natural Cedar	White
	156	Natural Slate	White
	146	Newport Bay	White
	52	Pebblestone Clay	White
	IB	Portsmouth Blue	White
	170	Quiet Willow	White
	149	Red Brick	White
	E9	Red Cedar	White
	353	Rock Harbor	White
	62	Royal Brown	White
	100	Rugged Canyon	White
	290	Russet Red	White
	18	Sage	White
	39	Sandtone	White
	510	Scottish Thistle	White
	02	Silver Grey	White
	34	Terra Bronze	White
	ID	Terra Cotta	White
	275	Timberstone	White
	511	Tuscan Olive	White
	36	Victorian Grey	White
	252	Vineyard Grove	White
	354	Whispering Timber	White
	A7	Wicker	White
	E4	Woodland Green	White
	355	Woodland Retreat	White
	276	Window Almond	Window White
	09	Window Bronze	White
	275	Window Brown	Window White
	274	Window White	Window White

*\*Colors indicated with an asterisk are not available in PVC coated.*

# Trim Sheet

## Mastic Colors

### Window Color Reference

Window Manufacturer	Color Name	Matching MHE Trim
General Windows	Window White/Window White	TS24 274, S24 274
General Windows	Window Almond/Window White	TS24 276, S24 276
General Windows	Window Bronze/White	TS24 09
General Windows	Window Brown/Window White	TS24 275, S24 275
Andersen	White/Canvas	S24 WA1
Andersen	Terratone/Sandtone	S24 WA2
Andersen	Cocoa Bean/Black	S24 WA5
Andersen	Dark Bronze/Red Rock	S24 WA4
Andersen	Forest Green/White	S24 WA6
Marvin	Arctic White	TS24 274
Marvin	Bahama Brown	TS24 62
Marvin	Black	TS24 33
Marvin	Bronze	*TS24 09
Marvin	Cadet Gray	SRL24 Y0
Marvin	Cashmere	TS24 A7
Marvin	Coconut Cream	TS24 31
Marvin	*Copper	TS24 135
Marvin	Desert Beige	S24 22
Marvin	Evergreen	SCR24 DP
Marvin	French Vanilla	*TS24 591
Marvin	Pebble Gray	SHL24 160
Marvin	Sherwood Green	TS24 70
Marvin	Sierra White	*S24 A8
Marvin	Stone White	TS24 04
Marvin	White	TS24 04
Marvin	Wineberry	TS24 755
Pella	Black	*TS24 33
Pella	Brown	TS24 JS
Pella	Poplar White	*TS24 APP
Pella	Putty	*TS24 APQ
Pella	Tan	*TS24 PT
Ply Gem	Adobe Clay (vinyl)	WC24 A5
Ply Gem	Almond (BS)	SCR24 CH
Ply Gem	Beige (vinyl)	SCR24 CH
Ply Gem	Black (Mira)	*TS24 33
Ply Gem	Bronze (aluminum)	*TS24 09
Ply Gem	Camel/Beige	TS24 WY
Ply Gem	Clay	TS24 62
Ply Gem	Cottage Red (Mira)	*TS24 755
Ply Gem	Dark Bronze (Mira)	*TS24 09
Ply Gem	Earhtone	TS24 WU
Ply Gem	Ivory (Mira)	*TS24 APP
Ply Gem	Sandstone	TS24 WV
Ply Gem	White (all vinyl extrusions except BS1100)	TS24 04
Ply Gem	White (BS1100)	TS24 274
Ply Gem	White (Mira)	TS24 04
Simonton	Tan	TS24 276
Simonton	White	TS24 04

\*Colors indicated with an asterisk are not available in PVC coated.

\*\*Colors indicated with double asterisk are special order only, 10 day lead time, 60 carton min

The listed products are "best available" match and must be customer approved using a sample.

# Trim Sheet

## Mastic Colors

Product Code/Description	Color Code	Color on Front	Color on Back
TS24TX <b>PVC Texture Coated 24" Trim Sheet</b> (Coated one side) Finish: PVC Textured Nominal .019 Thick Length: 50' 1 Roll/Ctn. 27.5 Lbs./Ctn.  <i>Note: The PVC texture finish has less woodgrain definition than striation.</i>	WX	Window White	
TS24150 <b>Smooth 24" Trim Sheet</b> (Coated two sides) Finish: AlumaLure 2000® Nominal .019 Thick Length: 150' 1 Roll/Ctn. 74 Lbs./Ctn.	04	White	White
TS24024 <b>Smooth 24" Ultra TS®</b> (Coated two sides) Finish: AlumaLure 2000® Nominal .024 Thick Length: 50' 1 Roll/Ctn. 33.2 Lbs./Ctn.	04 53 33 44 59 52 62 A7	White Almond Black Linen Musket Brown Pebblestone Clay Royal Brown Wicker	White White White White White White White White
TS24024T <b>PVC Coated 24" Ultra TS®</b> (Coated one side) Finish: PVC Striated Nominal .024 Thick Length: 50' 1 Roll/Ctn. 35.5 Lbs./Ctn.	04 59	White Musket Brown	

Notes:

# Trim Sheet

## Mastic Colors

Product Code/Description	Color Code	Color on Front	Color on Back
TS14	04	White	White
<b>Smooth</b>	59	Musket Brown	White
<b>14" Trim Sheet</b>			
(Coated two sides)			
Finish: Alupalure 2000®			
Nominal .019 Thick			
Length: 50'			
1 Roll/Ctn.			
15 Lbs./Ctn.			

Notes:

# Trim Sheet

## CertainTeed Colors

Product Code/Description	Color Code	Color on Front	Color on Back
WC24	A2	Colonial White	White
<b>Smooth</b>	WF	Arbor Blend	White
<b>24" Trim Sheet</b>	347	*Autumn Red	White
<b>CertainTeed Colors</b>	AY	Autumn Yellow	White
(Coated two sides)	BU	Buckskin	White
Finish: AlumaLure 2000®	WB	*Canyon Blend	White
Nominal .019 Thick	XJ	Castle Stone	White
Length: 50'	090	Charcoal Gray	White
1 Roll/Ctn.	K2	Cypress	White
24.6 Lbs./Ctn.	R3	Desert Tan	White
	349	Espresso	White
	RA	Flagstone	White
	346	*Forest	White
	CF	*Frontier Blend	White
	A4	Glacier Blend	White
	S2	Granite Gray	White
	344	*Green Tea	White
	348	*Hearthstone	White
	A9	Heritage Cream	White
	C3	Herringbone	White
	T6	Ivy Green	White
	N5	Light Maple	White
	K6	*Linen	White
	276	Meadow Blend	White
	358	Midnight Blue	White
	A5	Natural Clay	White
	A6	Oxford Blue	White
	T8	Pacific Blue	White
	T7	Sable Brown	White
	AS	*Sandpiper	White
	R5	Sandstone Beige	White
	R1	Savannah Wicker	White
	510	*Seagrass	White
	S5	Silver Ash	White
	JS	Slate	White
	A2	*Snow	White
	345	*Spruce	White
	A4	Sterling Gray	White
	AT	*Suede	White
	ID	Terra Cotta	White
	A5	Timber Blend	White
	C1	Warm Sand	White
	WE	Weathered Blend	White

Other Colors: minimum order required

\*Colors indicated with an asterisk are not available in PVC coated.

### Notes:

# Trim Coil

## Mastic Colors

Product Code/Description	Color Code	Color on Front	Color on Back	Color Code	Color on Front	Color on Back
S24	04	White	White	148	Mahogany	White
<b>Smooth</b>	53	Almond	White	144	Misty Shadow	White
<b>24" Trim Coil</b>	224	*Antique Ivory	White	IF	Montana Suede	White
(Coated two sides)	251	Autumn Harvest	White	59	Musket Brown	White
Finish: AlumaLure 2000®	33	Black	White	156	Natural Slate	White
Nominal .019 Thick	BM	*Black	Musket Brown	146	Newport Bay	White
Length: 50'	BR	*Black	Royal Brown	52	Pebblestone Clay	White
1 Roll/Ctn.	YR	Brandy	White	18	Portsmouth Blue	White
24.6 Lbs./Ctn.	147	Brandy Wood	White	170	Quiet Willow	White
	09	*Bronze	White	149	Red Brick	White
	31	Cameo	White	353	Rock Harbor	White
	80	*Charcoal Grey	White	62	Royal Brown	White
	30	Classic Cream	White	100	Rugged Canyon	White
	210	Corn Silk	White	290	Russet Red	White
	JS	Dark Bronze	White	18	Sage	White
	352	Deep Cavern	White	39	Sandstone	White
	090	Deep Granite	White	510	Scottish Thistle	White
	22	Desert Sand	White	02	Silver Grey	White
	390	English Wedgewood	White	34	Terra Bronze	White
	17	Everest	White	275	Timberstone	White
	70	Evergreen	White	511	Tuscan Olive	White
	262	Grecian Green	White	228	Tuxedo Gray	White
	35	Harbor Grey	White	36	Victorian Grey	White
	AO	Jefferson Tan	White	252	Vineyard Grove	White
	IC	Lakeshore Fern	White	354	Whispering Timber	White
	44	Linen	White	A7	Wicker	White
	JN	London Brown	White	355	Woodland Retreat	White

\*Colors indicated with an asterisk are not available in PVC coated.

S24150  
**Smooth**  
**24" Trim Coil**

Finish: AlumaLure 2000®  
Nominal .019 Thick  
Length: 150'  
1 Roll/Ctn.  
74.3 Lbs./Ctn.

04 White  
274 Window White

S24T150  
**PVC Coated**  
**24" Trim Coil**

Nominal .019 Thick  
Length: 150'  
1 Roll/Ctn.  
74.3 Lbs./Ctn.

04 White  
274 Window White

S24LM  
**Low Mar**  
**24" Trim Coil**

Finish: Textured Polymer  
Nominal .019 Thick  
Length: 50'  
1 Roll/Ctn.  
24.5 Lbs./Ctn.

04 White  
53 Almond  
33 Black  
59 Musket Brown  
52 Pebblestone Clay  
A7 Wicker  
62 Royal Brown  
JS Dark Bronze  
Window World  
274 Window White  
276 Window Almond  
Alside  
661 American Terra  
662 Castle Gray  
666 Desert Clay  
663 Forest Green  
664 Hudson Khaki  
665 English Red  
MI Window  
667 Almond

# Trim Coil

## Mastic Colors

Product Code/Description		Color Code	Color on Front	Color on Back		
<b>S24W</b> <b>Woodgrain Emboss</b> <b>24" Trim Coil</b>	Finish: Alupalure 2000® Nominal .019 Thick Length: 50' 1 Roll/Ctn. 24.5 Lbs./Ctn.	04	White			
		53	Almond			
		33	Black			
		31	Cameo			
		JS	Dark Bronze			
		22	Desert Sand			
		59	Musket Brown			
		52	Pebblestone Clay			
		34	Terra Bronze			
		A7	Wicker			
		<b>S14</b> <b>Smooth</b> <b>14" Trim Coil</b> (Coated two sides)	Finish: Alupalure 2000® Nominal .019 Thick Length: 50' 1 Roll/Ctn. 14.4 Lbs./Ctn.	04	White	White
				BM	Black	Musket Brown
				BR	Black	Royal Brown

Notes:

---

Notes:

# Trim Coil

## Royal Colors

Product Code/Description		Color Code	Color on Front	Color on Back
SRL24 <b>Smooth</b> <b>24" Trim Coil</b> <b>Royal Colors</b> (Coated two sides)	Finish: Alumalure 2000®	Y2	White	White
	Nominal .019 Thick	711	Bark	White
SRL24T <b>PVC Coated</b> <b>24" Trim Coil</b> <b>Royal Colors</b> (Coated one side)	Length: 50'	Y1	Blue Gray	White
	1 Roll/Ctn. 24.6 Lbs./Ctn.	CT	Brownstone	White
		62	Cocoa	White
		XH	Cypress	White
		XI	Flagstone	White
		34	Granite	White
		XJ	Harvard Slate	White
		XK	Heather	White
		XL	*Heritage Blue	White
		228	Ironstone	White
		Y6	Linen	White
		865	Marine Blue	White
		T8	Midnight Surf	White
		RV	Pebble Clay	White
		290	Redwood	White
		BU	Sable	White
		Y3	Sand	White
		IG	Shamrock	White
		XN	Soft Maple	White
		Y8	Sterling	White
		RA	Storm	White
		IF	Toasted Almond	White
		170	Tree Moss	White
		Y9	Vintage Cream	White
		100	Walnut	White
		225	*Weathered Gray	White
		D9	Wedgewood	White
		Y7	Wicker	White

*Other Colors: minimum order required*

*\*Colors indicated with an asterisk are not available in PVC coated.*

# Trim Coil

## Exterior Portfolio/Crane Colors

Product Code/Description	Color Code	Color on Front	Color on Back
<b>SCR24</b> <b>Smooth</b> <b>24" Trim Coil</b> <b>Crane Colors</b> (Coated two sides) Finish: Alumalure 2000® Nominal .019 Thick Length: 50' 1 Roll/Ctn. 24.6 Lbs./Ctn.	CV	Aspen White	White
	CY	Bone	White
	IF	Canyon	White
	866	Carbon	White
	CT	Clay	White
	CH	Country Beige	White
	DS	Cypress	White
	CZ	Driftwood	White
	711	Espresso	White
	DK	Graphite	White
	CJ	Graystone	White
	CI	Harbor Blue	White
	170	Hillsdale Green	White
	BU	Honey Oak	White
	865	Indigo	White
	DN	Lighthouse Red	White
	CX	Mocha	White
	ID	Nutmeg	White
	RA	Oceanside	White
	<b>SCR24T</b> <b>PVC Coated</b> <b>24" Trim Coil</b> <b>Crane Colors</b> (Coated one side) Finish: PVC Striated Nominal .019 Thick Length: 50' 1 Roll/Ctn. 26.2 Lbs./Ctn.	IC	Olive
CU		Pearl	White
DM		Regatta	White
CW		Rye	White
DF		Slate	White
DT		Wheat	White

*Other Colors: minimum order required*

*\*Colors indicated with an asterisk are not available in PVC coated.*

### Notes:

# Trim Coil

## Heartland Colors

Product Code/Description	Color Code	Color on Front	Color on Back
SHL24	H9	White	White
<b>Smooth</b>	H1	Almond	White
<b>24" Trim Coil</b>	L1	Antique White	White
<b>Heartland Colors</b>	170	Aspen	White
(Coated two sides)	HG	Birchwood	White
Finish: Alupalure 2000®	GK	*Camel	White
Nominal .019 Thick	100	Canyon	White
Length: 50'	39	Chateau	White
1 Roll/Ctn.	H4	Clay	White
24.6 Lbs./Ctn.	H5	Cream	White
	090	Granite	White
	H7	Gray	White
	HL	Linen	White
	K6	Mist	White
	CF	*Mocha	White
	T2	Mountain Berry	White
	G9	Pewter	White
	E8	*Prairie	White
	K2	Sage	White
	HH	Sand	White
	H8	Sandalwood	White
	K7	Sienna	White
	160	*Stone	White
SHL24T			
<b>PVC Coated</b>			
<b>24" Trim Coil</b>			
(Coated one side)			
Finish: PVC Striated			
Nominal .019 Thick			
Length: 50'			
1 Roll/Ctn.			
26.2 Lbs./Ctn.			

*Other Colors: minimum order required*

*\*Colors indicated with an asterisk are not available in PVC coated.*

### Notes:

# Trim Coil

## James Hardie Colors

Product Code/Description	Color Code	Color on Front	Color on Back
SJH24	643	*Aged Pewter	White
<b>Smooth</b>	9A	Alpine Frost	White
<b>24" Trim Coil</b>	9B	Arctic White	White
<b>James Hardie</b>	620	Autumn Tan	White
<b>Colors</b>	9D	Boothbay Blue	White
(Coated two sides)	621	*Chestnut Brown	White
Finish: AlumaLure 2000®	238	Cobble Stone	White
Nominal .019 Thick	622	*Countrylane Red	White
Length: 50'	627	*Deep Ocean	White
1 Roll/Ctn.	623	Evening Blue	White
24.6 Lbs./Ctn.	346	*Forest Pine	White
	628	*Gray Slate	White
	573	Heathered Moss	White
	624	*Iron Gray	White
	625	Khaki Brown	White
	02	Light Mist	White
	090	Metropolitan Grey	White
SJH24T	259	Monterey Taupe	White
<b>PVC Coated</b>	IC	Mountain Sage	White
<b>24" Trim Coil</b>	574	*Mulberry Wine	White
<b>James Hardie</b>	868	Nantucket	White
<b>Colors</b>	53	Navajo Beige	White
(Coated two sides)	629	*Night Gray	White
Finish: PVC Striated	36	Pearl Gray	White
Nominal .019 Thick	JN	Pebble Brown	White
Length: 50'	869	Peppercorn	White
1 Roll/Ctn.	867	Polaris	White
26.2 Lbs./Ctn.	644	*Rich Espresso	White
	851	Sail Cloth	White
	297	Sandstone Beige	White
	626	Timber Bark	White
	9W	Traditional Red	White
	GK	*Winslow Taupe	White
<i>Other Colors: minimum order required</i>	9X	Woodland Cream	White
	581	Woodstock Brown	White

\*Colors indicated with an asterisk are not available in PVC coated.

### Notes:

# Trim Coil

## KP Colors

Product Code/Description	Color Code	Color on Front	Color on Back
SKP24	LH	Almond	White
<b>Smooth</b>	DN	Barn Red	White
<b>24" Trim Coil</b>	210	Camel	White
<b>KP Colors</b>	CW	Canvas	White
(Coated two sides)	LR	Classic Linen	White
Finish: Alupalure 2000®	LJ	Clay	White
Nominal .019 Thick	LV	Cobblestone Wicker	White
Length: 50'	E4	Dusk	White
1 Roll/Ctn.	IG	Forest	White
24.6 Lbs./Ctn.	090	Graphite	White
	LT	Heritage Gray	White
	17	Heron	White
	LM	Khaki	White
	148	Mahogany	White
	T8	Ocean	White
	LS	Prairie Wheat	White
	53	Putty	White
	K2	Sage	White
	LU	Sandstone	White
	LN	Slate	White
	160	*Smoke	White
	ID	Spice	White
	100	Suede	White
	LP	Tan	White
	LQ	White	White

SKP24T  
**PVC Coated**  
**24" Trim Coil**  
**KP Colors**  
 (Coated one side)  
 Finish: PVC Striated  
 Nominal .019 Thick  
 Length: 50'  
 1 Roll/Ctn.  
 26.2 Lbs./Ctn.

*Other Colors: minimum order required*

*\*Colors indicated with an asterisk are not available in PVC coated.*

### Notes:

# Trim Coil

## Mitten Colors

Product Code/Description	Color Code	Color on Front	Color on Back
<b>SMN24</b> <b>Smooth</b> <b>24" Trim Coil</b> <b>Mitten Colors</b> (Coated two sides) Finish: Alumalure 2000® Nominal .019 Thick Length: 50' 1 Roll/Ctn. 24.6 Lbs./Ctn.	T8	Annapolis Blue	White
	NE	Bone	White
	CT	Brownstone	White
	148	Chestnut	White
	A5	Clay	White
	573	Cypress	White
	574	Eggplant	White
	585	Flagstone	White
	04	Frost	White
	IC	Grenadier Green	White
	JS	Gunmetal Grey	White
	A7	Hearthstone	White
	30	Ivory	White
	100	Khaki Brown	White
	39	Lite Maple	White
	575	*Muskoka Green	White
	157	*Richmond Red	White
	555	Rockaway Grey	White
	22	Sandcastle	White
	581	Spring Moss	White
583	Stratus	White	
626	Timber Bark	White	

\*Colors indicated with an asterisk are not available in PVC coated.

**SMN24T**  
**PVC Coated**  
**24" Trim Coil**  
**Mitten Colors**  
 (Coated two sides)  
 Finish: PVC Striated  
 Nominal .019 Thick  
 Length: 50'  
 1 Roll/Ctn.  
 26.2 Lbs./Ctn.

<b>SMN24C</b> <b>Smooth</b> <b>24" Trim Coil</b> <b>Mitten Colors</b> (Coated two sides) Finish: Alumalure 2000® Nominal .021 Thick Length: 30m 1 Roll/Ctn. 58.75 Lbs./Ctn.	569	Amber	White
	565	Ash	White
	570	Aviator Green	White
	568	Burnt Orange	White
	566	Caribou Brown	White
	586	Champagne	White
	572	Coffee Bean	White
	713	Danish Gold	White
	552	Iron Ore	White
	714	Lighthouse Red	White
	577	Rainforest	White
	587	Regatta Blue	White
	578	Saffron	White
	579	Sage	White
	557	Sandalwood	White
	716	Sapphire Blue	White
	580	Satin Grey	White
	558	State	White
	562	Tumblewood Tan	White

Other Colors: minimum order required

### Notes:

# Trim Coil

## Norandex Colors

Product Code/Description	Color Code	Color on Front	Color on Back
SNX24	53	Almond	White
<b>Smooth</b>	31	Beige	White
<b>24" Trim Coil</b>	N20	Cactus	White
<b>Norandex Colors</b>	238	Champagne	White
(Coated two sides)	N21	Cobblestone	White
Finish: Alupalure 2000®	30	Cream	White
Nominal .019 Thick	N5	Dune	White
Length: 50'	N32	Evergreen	White
1 Roll/Ctn.	N27	Fern	White
24.6 Lbs./Ctn.	DN	Fire Brick	White
	N23	Granite	White
	555	Graphite	White
	N30	Hazel	White
	N31	Ivy	White
	581	Khaki	White
	YT	Linen	White
	T7	Maverick Brown	White
	100	Mocha	White
	N26	Olive	White
	N29	Russet	White
	N33	Saddle	White
	LU	Sand	White
	A7	Sandstone	White
	RA	Seaport	White
	CT	Sierra	White
	O2	Silver	White
	CJ	Smoke	White
	N25	Steel Blue	White
	R3	Tan	White
	625	Tumbleweed	White
	N28	Wedgewood	White
	N22	Wheat	White
	O4	White	White
	AY	Yellow	White

*Other Colors: minimum order required*

*\*Colors indicated with an asterisk are not available in PVC coated.*

### Notes:

# Trim Coil

## Vytec Colors

Product Code/Description	Color Code	Color on Front	Color on Back
SVY24	NR	Antique Ivory	White
<b>Smooth</b>	NK	Autumn Ash	White
<b>24" Trim Coil</b>	581	Autumn Leaf	White
<b>Vytec Colors</b>	100	Canyon Ridge	White
(Coated two sides)	CJ	Castle Stone	White
Finish: Alumalure 2000®	02	Clipper Gray	White
Nominal .019 Thick	NJ	Desert	White
Length: 50'	575	*Forest	White
1 Roll/Ctn.	DF	Harbour	White
24.6 Lbs./Ctn.	EP	Horizon Blue	White
	NE	Irish Linen	White
	IB	Lakeshore Blue	White
	N5	Maplewood	White
	A7	Natural Sand	White
	DN	*Redwood	White
	CT	Rustic Clay	White
	IF	Shoreline	White
	NU	Sierra Brown	White
	DK	Smokestone	White
	579	*Tundra Moss	White
	NW	Twilight Gray	White

SVY24T

**PVC Coated**  
**24" Trim Coil**  
**Vytec Colors**

(Coated one side)  
Finish: PVC Striated  
Nominal .019 Thick  
Length: 50'  
1 Roll/Ctn.  
26.2 Lbs./Ctn.

*Other Colors: minimum order required*

*\*Colors indicated with an asterisk are not available in PVC coated.*

Notes:

# Trim Coil

## Mastic Colors (.018)

Product Code/Description	Color Code	Color on Front	Color on Back
EC24	04	White	White
<b>Smooth</b>	BM	Black	Musket Brown
<b>24" Trim Coil</b>	BR	Black	Royal Brown
(Coated two sides)	33	Black	White
Finish: Smooth Polymer	59	Musket Brown	White
Nominal .018 Thick	52	Pebblestone Clay	White
Length: 50'	276	Window Almond	Window White
1 Roll/Ctn.			
23.6 Lbs./Ctn.			

EC24T	04	White	
<b>PVC Coated</b>			
<b>24" Trim Coil</b>			
(Coated one side)			
Finish: PVC Striated			
Nominal .018 Thick			
Length: 50'			
1 Roll/Ctn.			
24 Lbs./Ctn.			

Notes:

# Envoy® Aluminum Siding

## Product Code/Description

## Color Availability

4NCR024

### Envoy Rustic Double 4" (.024)

Finish: Alupalure 2000®  
Nominal .024 Thick  
Length: 12' 6"  
24 Pcs./Ctn.  
2 Sqs./Ctn.  
90 Lbs./Ctn.

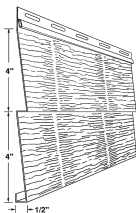

White  
Almond  
Charcoal Grey  
Desert Sand  
Everest  
Pebblestone Clay  
Rugged Canyon  
Sandtone  
Victorian Grey  
Wicker

5N090024

### Envoy Horizon Collection Double 5"

Finish: Alupalure 2000®  
Nominal .024 Thick  
Length: 12'  
20 Pcs./Ctn.  
2 Sqs./Ctn.  
86 Lbs./Ctn.

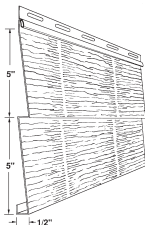

8NA

### Envoy 8" Smooth

Finish: Alupalure 2000®  
Nominal .024 Thick  
Length: 12' 6"  
24 Pcs./Ctn.  
2 Sqs./Ctn.  
84 Lbs./Ctn.

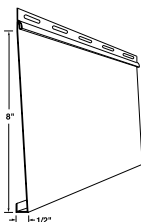

White

Notes:

# Endurance® Aluminum Siding

---

## Product Code/Description

---

4NCR

### Endurance Rustic Double 4"

Finish: AlumaLure 2000®

Nominal .019 Thick

Length: 12' 6"

24 Pcs./Ctn.

2 Sqs./Ctn.

71 Lbs./Ctn.

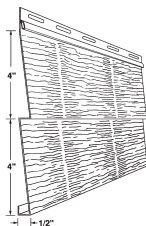

---

## Color Availability

---

White

Almond

Charcoal Grey

Desert Sand

Everest

Pebblestone Clay

Rugged Canyon

Sandtone

Victorian Grey

Wicker

---

D5090

### Endurance Dutch Oak Double 5" Dutch Lap

Finish: AlumaLure 2000®

Nominal .019 Thick

Length: 12'

20 Pcs./Ctn.

2 Sqs./Ctn.

67 Lbs./Ctn.

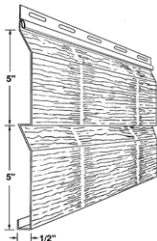

---

8NA019

### Endurance 8" Smooth

Finish: AlumaLure 2000®

Nominal .019 Thick

Length: 12' 6"

24 Pcs./Ctn.

2 Sqs./Ctn.

72 Lbs./Ctn.

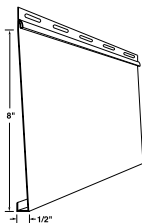

White

---

Notes:

# Aluminum Siding Accessories

Product Code/Description

Color Availability

1WAP10  
**Starter Strip**

Length: 10' 0"  
40 Pcs./Ctn.  
27 Lbs./Ctn.

*\*Required starter strip for  
Charleston Beaded and Ovation Beaded.*

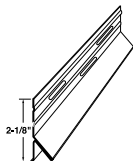

VSS10NS  
**Starter Strip Spring  
Style**

Length: 10' 0"  
50 Pcs./Ctn.  
33 Lbs./Ctn.

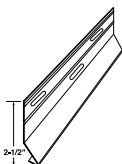

6N225NCR  
**Rustic Outside  
Aluminum Corner Post**

Finish: Alupalure 2000®  
Nominal .024 Thick  
Length: 10'  
10 Pcs./Ctn.  
31.7 Lbs./Ctn.

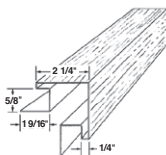

White  
Almond  
Charcoal Grey  
Desert Sand  
Everest  
Pebblestone Clay  
Rugged Canyon  
Sandtone  
Victorian Grey  
Wicker

6N225  
**Smooth Outside  
Aluminum Corner Post**

Finish: Alupalure 2000®  
Nominal .024 Thick  
Length: 10'  
10 Pcs./Ctn.  
31.7 Lbs./Ctn.

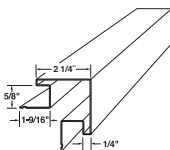

White

Notes:

# Aluminum Siding Accessories

---

## Product Code/Description

---

2JN2A25  
**Window Trim "J" Style**

Finish: AlumaLure 2000®  
 Nominal .019 Thick  
 Length: 12' 0"  
 25 Pcs./Ctn.  
 18.8 Lbs./Ctn.

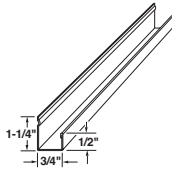

---

## Color Availability

---

White  
 Almond  
 Charcoal Grey  
 Desert Sand  
 Everest  
 Pebblestone Clay  
 Sandtone  
 Victorian Grey

---

3F  
**Window Head Flashing**

Finish: AlumaLure 2000®  
 Nominal .019 Thick  
 Length: 12' 6"  
 20 Pcs./Ctn.  
 16.8 Lbs./Ctn.

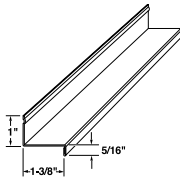

White  
 Black  
 Classic Cream  
 Dark Bronze  
 Forest  
 Jefferson Tan  
 Musket Brown  
 Pebblestone Clay  
 Royal Brown

Rugged Canyon  
 Russet Red  
 Terra Bronze  
 Wicker

---

**Notes:**

# Envoy® Aluminum Soffit

## Product Code/Description

## Color Availability

SVG12N20

### Envoy Double 6" Solid V-Groove Soffit

Finish: AlumaLure 2000®  
Nominal .019 Thick  
Length: 12"  
Exposure: 12"  
20 Pcs./Ctn.  
240 Sq. Ft./Ctn.  
75 Lbs./Ctn.

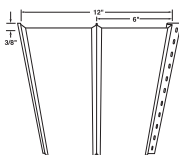

White  
Almond  
Black  
Cameo  
Charcoal Grey  
Classic Cream  
Dark Bronze  
Desert Sand  
Evergreen  
Harbor Grey  
Jefferson Tan  
Linen  
London Brown  
Montana Suede  
Musket Brown  
Pebblestone Clay  
Royal Brown  
Rugged Canyon  
Russet Red  
Sandtone  
Silver Grey  
Terra Bronze  
Victorian Grey  
Wicker

SVG12V20

### Envoy Double 6" Perforated V-Groove Soffit

Finish: AlumaLure 2000®  
Nominal .019 Thick  
15 Sq. In. N.F.A./Ft.  
Length: 12"  
Exposure: 12"  
20 Pcs./Ctn.  
240 Sq. Ft./Ctn.  
67 Lbs./Ctn.

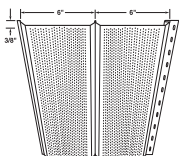

SVG6N

### Envoy 6" Solid V-Groove Soffit

Finish: AlumaLure 2000®  
Nominal .019 Thick  
Length: 12"  
Exposure: 6"  
20 Pcs./Ctn.  
120 Sq. Ft./Ctn.  
43 Lbs./Ctn.

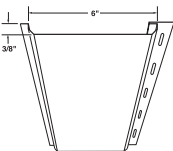

White  
Almond  
Charcoal Grey  
Evergreen  
Musket Brown  
Pebblestone Clay  
Sandtone  
Terra Bronze

SVG6V

### Envoy 6" Perforated V-Groove Soffit

Finish: AlumaLure 2000®  
Nominal .019 Thick  
7.5 Sq. In. N.F.A./Ft.  
Length: 12"  
Exposure: 6"  
20 Pcs./Ctn.  
120 Sq. Ft./Ctn.  
39 Lbs./Ctn.

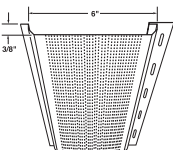

White

# Envoy® Aluminum Soffit

---

Product Code/Description

---

Color Availability

SAS12219

**Envoy**  
**Double 6" Solid**  
**U-Groove Soffit**

Finish: AlumaLure 2000®  
Nominal .019 Thick  
Length: 12'  
Exposure: 12"  
20 Pcs./Ctn.  
240 Sq. Ft./Ctn.  
76.1 Lbs./Ctn.

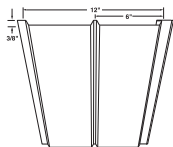

White  
Musket Brown

---

LFAS12219

**Envoy**  
**Double 6" Lanced**  
**U-Groove Soffit**

Finish: AlumaLure 2000®  
Nominal .019 Thick  
10.6 Sq. In. N.F.A./Ft.  
Length: 12'  
Exposure: 12"  
20 Pcs./Ctn.  
240 Sq. Ft./Ctn.  
76.1 Lbs./Ctn.

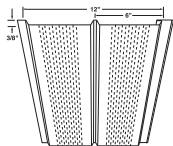

---

Notes:

# Envoy® Aluminum Soffit

## Product Code/Description

## Color Availability

SAS12319

**Envoy  
Triple 4" Solid  
U-Groove Soffit**

Finish: Alupalure 2000®  
Nominal .019 Thick  
Length: 12"  
Exposure: 12"  
20 Pcs./Ctn.  
240 Sq. Ft./Ctn.  
77.7 Lbs./Ctn.

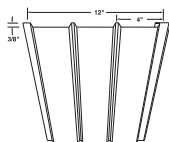

White  
Almond  
Black  
Brandy Wood  
Cameo  
Charcoal Grey  
Classic Cream  
Dark Bronze  
Desert Sand  
Everest  
Evergreen  
Harbor Grey  
Jefferson Tan  
Linen  
London Brown  
Mahogany  
Montana Suede  
Musket Brown  
Pebblestone Clay  
Royal Brown  
Rugged Canyon  
Russet Red  
Sandtone  
Scottish Thistle  
Silver Grey  
Terra Bronze  
Tuscan Olive  
Victorian Grey  
Wicker

LCAS12319

**Envoy  
Triple 4" Center Lanced  
U-Groove Soffit**

Finish: Alupalure 2000®  
Nominal .019 Thick  
4.4 Sq. In. N.F.A./Ft.  
Length: 12"  
Exposure: 12"  
20 Pcs./Ctn.  
240 Sq. Ft./Ctn.  
77.7 Lbs./Ctn.

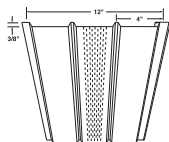

LFAS12319

**Envoy  
Triple 4" Full Lanced  
U-Groove Soffit**

Finish: Alupalure 2000®  
Nominal .019 Thick  
13.2 Sq. In. N.F.A./Ft.  
Length: 12"  
Exposure: 12"  
20 Pcs./Ctn.  
240 Sq. Ft./Ctn.  
77.7 Lbs./Ctn.

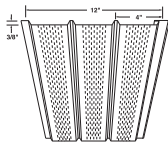

Notes:

# Envoy® Aluminum Soffit

---

## Product Code/Description

SAS16419A

**Envoy  
Quad 4" Solid  
U-Groove Soffit**

Finish: AlumaLure 2000®  
Nominal .019 Thick  
Length: 12'  
Exposure: 16"  
14 Pcs./Ctn.  
220 Sq. Ft./Ctn.  
74.2 Lbs./Ctn.

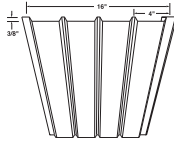

---

## Color Availability

White  
Almond  
Black  
Cameo  
Charcoal Grey  
Classic Cream  
Dark Bronze  
Desert Sand  
Evergreen  
Harbor Grey  
Jefferson Tan  
Linen  
Montana Suede  
Musket Brown  
Pebblestone Clay  
Royal Brown  
Rugged Canyon  
Russet Red  
Sandtone  
Silver Grey  
Terra Bronze  
Victorian Grey  
Wicker

---

LCAS16419A

**Envoy  
Quad 4" Center  
Lanced U-Groove Soffit**

Finish: AlumaLure 2000®  
Nominal .019 Thick  
9.7 Sq. In. N.F.A./Ft.  
Length: 12'  
Exposure: 16"  
14 Pcs./Ctn.  
220 Sq. Ft./Ctn.  
74.2 Lbs./Ctn.

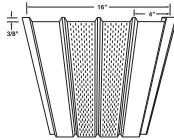

---

Notes:

# Endurance® Aluminum Soffit

## Product Code/Description

## Color Availability

SVGN420144  
**Endurance**  
**Double 6" Solid**  
**V-Groove Soffit**

Finish: AlumaLure 2000®  
 Nominal .016 Thick  
 Length: 12"  
 Exposure: 12"  
 20 Pcs./Ctn.  
 240 Sq Ft./Ctn.  
 65 Lbs./Ctn.

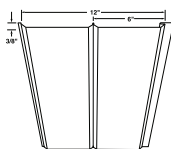

White  
 Almond  
 Black  
 Cameo  
 Charcoal Grey  
 Classic Cream  
 Dark Bronze  
 Desert Sand  
 Evergreen  
 Harbor Grey  
 Linen  
 Montana Suede  
 Musket Brown  
 Pebblestone Clay  
 Royal Brown  
 Russet Red  
 Sandtone  
 Silver Grey  
 Terra Bronze  
 Victorian Grey  
 Wicker

SVG420144  
**Endurance**  
**Double 6" Perforated**  
**V-Groove Soffit**

Finish: AlumaLure 2000®  
 Nominal .016 Thick  
 15 Sq. In. N.F.A./Ft.  
 Length: 12"  
 Exposure: 12"  
 20 Pcs./Ctn.  
 240 Sq Ft./Ctn.  
 59 Lbs./Ctn.

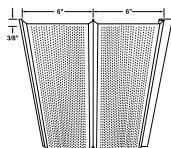

SAS12216  
**Endurance**  
**Double 6" Solid**  
**U-Groove Soffit**

Finish: AlumaLure 2000®  
 Nominal .016 Thick  
 Length: 12"  
 Exposure: 12"  
 20 Pcs./Ctn.  
 240 Sq Ft./Ctn.  
 67 Lbs./Ctn.

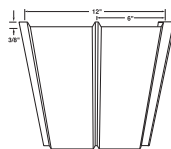

White  
 Musket Brown

LFAS12216  
**Endurance**  
**Double 6" Lanced**  
**U-Groove Soffit**

Finish: AlumaLure 2000®  
 Nominal .016 Thick  
 10.6 Sq. In. N.F.A./Ft.  
 Length: 12"  
 Exposure: 12"  
 20 Pcs./Ctn.  
 240 Sq Ft./Ctn.  
 67 Lbs./Ctn.

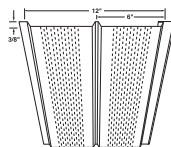

# Endurance® Aluminum Soffit

Product Code/Description

Color Availability

SAS12316  
**Endurance**  
**Triple 4" Solid**  
**U-Groove Soffit**

Finish: AlumaLure 2000®  
 Nominal .016 Thick  
 Length: 12'  
 Exposure: 12"  
 20 Pcs./Ctn.  
 240 Sq Ft./Ctn.  
 68 Lbs./Ctn.

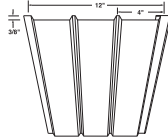

White  
 Almond  
 Black  
 Cameo  
 Charcoal Grey  
 Classic Cream  
 Dark Bronze  
 Desert Sand  
 Evergreen  
 Harbor Grey  
 Jefferson Tan  
 Linen  
 London Brown  
 Montana Suede  
 Musket Brown  
 Pebblestone Clay  
 Royal Brown  
 Rugged Canyon  
 Russet Red  
 Sandtone  
 Silver Grey  
 Terra Bronze  
 Victorian Grey  
 Wicker

LCAS12316  
**Endurance**  
**Triple 4" Center Lanced**  
**U-Groove Soffit**

Finish: AlumaLure 2000®  
 Nominal .016 Thick  
 4.4 Sq. In. N.F.A./Ft.  
 Length: 12'  
 Exposure: 12"  
 20 Pcs./Ctn.  
 240 Sq Ft./Ctn.  
 69 Lbs./Ctn.

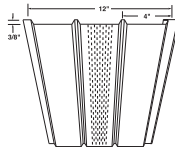

LFAS12316  
**Endurance**  
**Triple 4" Full Lanced**  
**U-Groove Soffit**

Finish: AlumaLure 2000®  
 Nominal .016 Thick  
 13.2 Sq. In. N.F.A./Ft.  
 Length: 12'  
 Exposure: 12"  
 20 Pcs./Ctn.  
 240 Sq Ft./Ctn.  
 68 Lbs./Ctn.

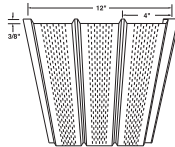

# Economy Aluminum Soffit

Product Code/Description

Color Availability

SAS12313

**Economy  
Triple 4" Solid  
U-Groove Soffit**

Finish: Alupalure 2000®

Nominal .013 Thick

Length: 12"

Exposure: 12"

20 Pcs./Ctn.

240 Sq Ft./Ctn.

56 Lbs./Ctn.

White

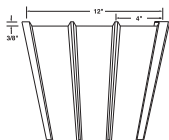

LCAS12313

**Economy  
Triple 4" Center Lanced  
U-Groove Soffit**

Finish: Alupalure 2000®

Nominal .013 Thick

4.4 Sq. In. N.F.A./Ft.

Length: 12"

Exposure: 12"

20 Pcs./Ctn.

240 Sq Ft./Ctn.

56 Lbs./Ctn.

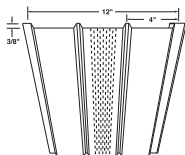

LFAS12313

**Economy  
Triple 4" Full Lanced  
U-Groove Soffit**

Finish: Alupalure 2000®

Nominal .013 Thick

13.2 Sq. In. N.F.A./Ft.

Length: 12"

Exposure: 12"

20 Pcs./Ctn.

240 Sq Ft./Ctn.

56 Lbs./Ctn.

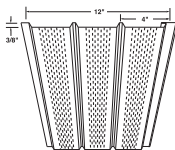

# Economy Aluminum Soffit

---

Product Code/Description

---

Color Availability

LFAS16413

**Economy  
Quad 4" Full Lanced  
U-Groove Soffit**

Finish: Alumalure 2000®  
Nominal .013 Thick  
5.16 Sq. In. N.F.A./Ft.  
Length: 12'  
Exposure: 16'  
18 Pcs./Ctn.  
288 Sq Ft./Ctn.  
65.25 Lbs./Ctn.

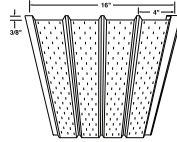

White  
Royal Brown  
Dark Bronze

---

SAS16413

**Economy  
Quad 4" Solid  
U-Groove Soffit**

Finish: Alumalure 2000®  
Nominal .013 Thick  
5.16 Sq. In. N.F.A./Ft.  
Length: 12'  
Exposure: 16'  
18 Pcs./Ctn.  
288 Sq Ft./Ctn.  
65.25 Lbs./Ctn.

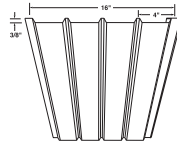

White  
Royal Brown  
Dark Bronze

# Aluminum Fascia

## Product Code/Description

## Color Availability

F1C425  
**Envoy Smooth**  
**4" Fascia Trim**

Finish: Alupalure 2000®  
 Nominal .024 Thick  
 Length: 12'  
 25 Pcs./Ctn.  
 41 Lbs./Ctn.

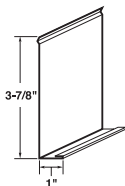

White  
 Almond  
 Black  
 Cameo  
 Dark Bronze  
 Desert Sand  
 Evergreen  
 Linen  
 Montana Suede  
 Musket Brown  
 Pebblestone Clay  
 Royal Brown  
 Sandtone  
 Terra Bronze  
 Wicker

F1C625  
**Envoy Smooth**  
**6" Fascia Trim**

Finish: Alupalure 2000®  
 Nominal .024 Thick  
 Length: 12'  
 25 Pcs./Ctn.  
 55 Lbs./Ctn.

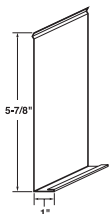

White  
 Almond  
 Black  
 Cameo  
 Charcoal Grey  
 Classic Cream  
 Copper Penny  
 Dark Bronze  
 Desert Sand  
 Everest  
 Evergreen  
 Harbor Grey  
 Jefferson Tan  
 Linen  
 London Brown  
 Montana Suede  
 Musket Brown  
 Pebblestone Clay  
 Royal Brown  
 Rugged Canyon  
 Russet Red  
 Sandtone  
 Scottish Thistle  
 Silver Grey  
 Terra Bronze  
 Tuscan Olive  
 Victorian Grey  
 Wicker

F1C825  
**Envoy Smooth**  
**8" Fascia Trim**

Finish: Alupalure 2000®  
 Nominal .024 Thick  
 Length: 12'  
 25 Pcs./Ctn.  
 71 Lbs./Ctn.

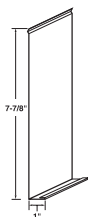

White  
 Almond  
 Cameo  
 Dark Bronze  
 Desert Sand  
 Linen  
 Musket Brown  
 Pebblestone Clay  
 Terra Bronze  
 Wicker

F1C1025  
**Envoy Smooth**  
**10" Fascia Trim**

Finish: Alupalure 2000®  
 Nominal .024 Thick  
 Length: 12'  
 25 Pcs./Ctn.  
 85 Lbs./Ctn.



# Aluminum Fascia

---

## Product Code/Description

---

F1C4025  
**Envoy Wood Grain Embossed  
 4" Fascia Trim**

Finish: Alupalure 2000®  
 Nominal .024 Thick  
 Length: 12'  
 25 Pcs./Ctn.  
 41 Lbs./Ctn.

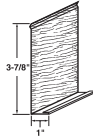

---

## Color Availability

---

White  
 Almond  
 Black  
 Cameo  
 Dark Bronze  
 Desert Sand  
 Evergreen  
 Linen  
 Montana Suede  
 Musket Brown  
 Pebblestone Clay  
 Royal Brown  
 Sandtone  
 Terra Bronze  
 Wicker

---

F1C6025  
**Envoy Wood Grain Embossed  
 6" Fascia Trim**

Finish: Alupalure 2000®  
 Nominal .024 Thick  
 Length: 12'  
 25 Pcs./Ctn.  
 55 Lbs./Ctn.

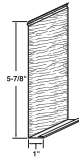

White  
 Almond  
 Black  
 Cameo  
 Charcoal Grey  
 Classic Cream  
 Dark Bronze  
 Desert Sand  
 Everest  
 Evergreen  
 Harbor Grey  
 Jefferson Tan  
 Linen  
 London Brown  
 Montana Suede  
 Musket Brown  
 Pebblestone Clay  
 Royal Brown  
 Rugged Canyon  
 Russet Red  
 Sandtone  
 Scottish Thistle  
 Silver Grey  
 Terra Bronze  
 Tuscan Olive  
 Victorian Grey  
 Wicker

---

F1C8025  
**Envoy Wood Grain Embossed  
 8" Fascia Trim**

Finish: Alupalure 2000®  
 Nominal .024 Thick  
 Length: 12'  
 25 Pcs./Ctn.  
 71 Lbs./Ctn.

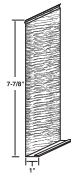

White  
 Almond  
 Cameo  
 Dark Bronze  
 Desert Sand  
 Linen  
 Musket Brown  
 Pebblestone Clay  
 Terra Bronze  
 Wicker

---

F1C10025  
**Envoy Wood Grain Embossed  
 10" Fascia Trim**

Finish: Alupalure 2000®  
 Nominal .024 Thick  
 Length: 12'  
 25 Pcs./Ctn.  
 85 Lbs./Ctn.

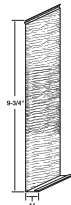

PERFORMANCE METALS®

# Aluminum Fascia

## Product Code/Description

## Color Availability

F1C4SR02425

### Envoy Ribbed 4" Fascia Trim

Finish: Alumalure 2000®  
Nominal .024 Thick  
Length: 12'  
25 Pcs./Ctn.  
41 Lbs./Ctn.

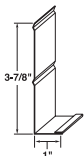

White  
Almond  
Black  
Cameo  
Dark Bronze  
Desert Sand  
Evergreen  
Linen  
Montana Suede  
Musket Brown  
Pebblestone Clay

Royal Brown  
Sandtone  
Terra Bronze  
Wicker

F1C6SR02425

### Envoy Ribbed 6" Fascia Trim

Finish: Alumalure 2000®  
Nominal .024 Thick  
Length: 12'  
25 Pcs./Ctn.  
55 Lbs./Ctn.

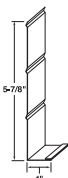

White  
Almond  
Black  
Cameo  
Charcoal Grey  
Classic Cream  
Copper Penny  
Dark Bronze  
Desert Sand  
Everest  
Evergreen  
Harbor Grey  
Jefferson Tan  
Linen  
London Brown  
Montana Suede  
Musket Brown  
Pebblestone Clay  
Royal Brown  
Rugged Canyon  
Russet Red  
Sandtone  
Scottish Thistle  
Silver Grey  
Terra Bronze  
Tuscan Olive  
Victorian Grey  
Wicker

F1C8SR02425

### Envoy Ribbed 8" Fascia Trim

Finish: Alumalure 2000®  
Nominal .024 Thick  
Length: 12'  
25 Pcs./Ctn.  
71 Lbs./Ctn.

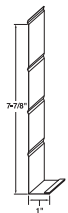

White  
Almond  
Cameo  
Dark Bronze  
Desert Sand  
Linen  
Musket Brown  
Pebblestone Clay  
Terra Bronze  
Wicker

F1C10SR02425

### Envoy Ribbed 10" Fascia Trim

Finish: Alumalure 2000®  
Nominal .024 Thick  
Length: 12'  
25 Pcs./Ctn.  
85 Lbs./Ctn.

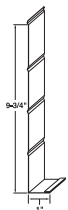

# Aluminum Fascia

---

## Product Code/Description

---

FC4SR

**4" Fascia**  
**Smooth Ribbed Hemmed**

Finish: Two-Coat Acrylic  
 Nominal .024 Thick  
 Length: 12'  
 25 Pcs./Ctn.  
 300 Lf./Ctn.  
 39 Lbs./Ctn.

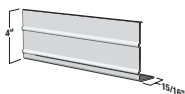

---

## Color Availability

---

White  
 Almond  
 Black  
 Dark Bronze  
 Desert Sand  
 Musket Brown  
 Royal Brown  
 Terra Bronze  
 Wicker

FC6SR

**6" Fascia**  
**Smooth Ribbed Hemmed**

Finish: Two-Coat Acrylic  
 Nominal .024 Thick  
 Length: 12'  
 25 Pcs./Ctn.  
 300 Lf./Ctn.  
 53.1 Lbs./Ctn.

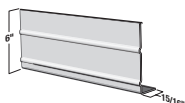

White  
 Almond  
 Black  
 Classic Cream  
 Dark Bronze  
 Desert Sand  
 Evergreen  
 Jefferson Tan  
 Musket Brown  
 Montana Suede  
 Pebblestone Clay  
 Royal Brown  
 Rugged Canyon  
 Sandtone  
 Scottish Thistle  
 Tuscan Olive  
 Terra Bronze  
 Wicker

FC8SR

**8" Fascia**  
**Smooth Ribbed Hemmed**

Finish: Two-Coat Acrylic  
 Nominal .024 Thick  
 Length: 12'  
 25 Pcs./Ctn.  
 300 Lf./Ctn.  
 69 Lbs./Ctn.

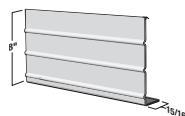

White  
 Almond  
 Dark Bronze  
 Desert Sand  
 Musket Brown  
 Terra Bronze  
 Wicker

FC10SR

**10" Fascia**  
**Smooth Ribbed Hemmed**

Finish: Two-Coat Acrylic  
 Nominal .024 Thick  
 Length: 12'  
 25 Pcs./Ctn.  
 300 Lf./Ctn.  
 83 Lbs./Ctn.

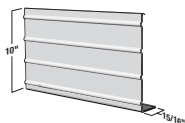

Notes:

---

# Aluminum Fascia

## Product Code/Description

## Color Availability

F1C4SR25  
**Endurance Ribbed  
 4" Fascia Trim**

Finish: AlumaLure 2000®  
 Nominal .019 Thick  
 Length: 12'  
 25 Pcs./Ctn.  
 35 Lbs./Ctn.

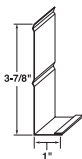

White  
 Almond  
 Cameo  
 Dark Bronze  
 Desert Sand  
 Linen  
 Musket Brown  
 Pebblestone Clay  
 Royal Brown  
 Terra Bronze  
 Wicker

F1C6SR25  
**Endurance Ribbed  
 6" Fascia Trim**

Finish: AlumaLure 2000®  
 Nominal .019 Thick  
 Length: 12'  
 25 Pcs./Ctn.  
 47 Lbs./Ctn.

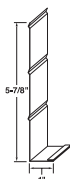

White  
 Almond  
 Black  
 Cameo  
 Charcoal Grey  
 Classic Cream  
 Dark Bronze  
 Desert Sand  
 Evergreen  
 Jefferson Tan  
 Linen  
 Montana Suede  
 Musket Brown  
 Pebblestone Clay  
 Royal Brown  
 Rugged Canyon  
 Russet Red  
 Sandtone  
 Terra Bronze  
 Wicker

F1C8SR25  
**Endurance Ribbed  
 8" Fascia Trim**

Finish: AlumaLure 2000®  
 Nominal .019 Thick  
 Length: 12'  
 25 Pcs./Ctn.  
 59 Lbs./Ctn.

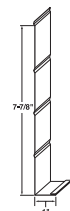

White  
 Almond  
 Cameo  
 Dark Bronze  
 Desert Sand  
 Musket Brown  
 Pebblestone Clay  
 Terra Bronze  
 Wicker

F1C10SR25  
**Endurance Ribbed  
 10" Fascia Trim**

Finish: AlumaLure 2000®  
 Nominal .019 Thick  
 Length: 12'  
 25 Pcs./Ctn.  
 72 Lbs./Ctn.

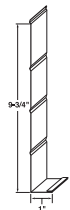

White  
 Almond  
 Classic Cream  
 Wicker

GRT6SR12  
**Gable Rake  
 6" Fascia Trim**

Finish: AlumaLure 2000®  
 Nominal .019 Thick  
 Length: 12'  
 12 Pcs./Ctn.  
 27 Lbs./Ctn.

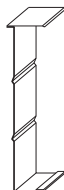

# Aluminum Soffit and Fascia Accessories

## Product Code/Description

## Color Availability

4APN20

### General Purpose Trim

Finish: Alumalure 2000®

Nominal .019 Thick

Length: 12' 6"

20 Pcs./Ctn.

14.3 Lbs./Ctn.

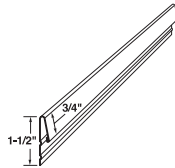

White  
Almond  
Black  
Cameo  
Charcoal Grey  
Classic Cream  
Dark Bronze  
Desert Sand  
Evergreen  
Linen  
Montana Suede

Musket Brown  
Pebblestone Clay  
Royal Brown  
Rugged Canyon  
Russet Red  
Sandtone  
Terra Bronze  
Tuscan Olive  
Victorian Grey  
Wicker

GT2125

### Gable Trim

Finish: Alumalure 2000®

Nominal .019 Thick

Length: 12' 1"

20 Pcs./Ctn.

34 Lbs./Ctn.

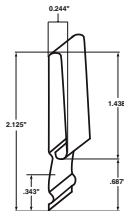

White  
Black  
Classic Cream  
Dark Bronze  
Evergreen

Musket Brown  
Royal Brown  
Rugged Canyon  
Terra Bronze  
Wicker

F438

### "J" Channel - 3/8" 1" Face, Offset

Finish: Alumalure 2000®

Nominal .019 Thick

Length: 12' 1"

40 Pcs./Ctn.

42 Lbs./Ctn.

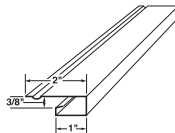

White  
Almond  
Black  
Cameo  
Charcoal Grey  
Classic Cream  
Dark Bronze  
Desert Sand  
Evergreen  
Harbor Grey  
Jefferson Tan  
Linen  
Montana Suede

Musket Brown  
Pebblestone Clay  
Royal Brown  
Rugged Canyon  
Russet Red  
Sandtone  
Silver Grey  
Terra Bronze  
Victorian Grey  
Wicker

Use: 3/8" Soffit

F438425

### "J" Channel - 3/8" 3/4" Face

Finish: Alumalure 2000®

Nominal .016 Thick

Length: 12' 0"

25 Pcs./Ctn.

19 Lbs./Ctn.

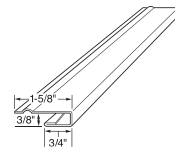

White  
Almond  
Black  
Brandy Wood  
Cameo  
Charcoal Grey  
Classic Cream  
Dark Bronze  
Desert Sand  
Everest  
Evergreen  
Harbor Grey  
Jefferson Tan  
Linen  
London Brown

Mahogany  
Montana Suede  
Musket Brown  
Pebblestone Clay  
Royal Brown  
Rugged Canyon  
Russet Red  
Sandtone  
Scottish Thistle  
Silver Grey  
Terra Bronze  
Tuscan Olive  
Victorian Grey  
Wicker

Use: 3/8" Soffit

# Aluminum Soffit and Fascia Accessories

## Product Code/Description

## Color Availability

SJ1625

### "J" Channel - 1/2" 3/4" Face

Finish: Alupalure 2000®

Nominal .016 Thick

Length: 12' 0"

25 Pcs./Ctn.

18 Lbs./Ctn.

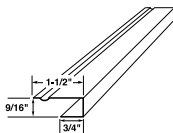

Use: 1/2" Soffit

White  
Almond  
Black  
Cameo  
Classic Cream  
Dark Bronze  
Desert Sand  
Evergreen  
Linen  
Musket Brown  
Pebblestone Clay  
Royal Brown

Rugged Canyon  
Sandtone  
Silver Grey  
Terra Bronze  
Wicker

58ALJ25

### J-Channel - 5/8" 1" Face

Finish: Alupalure 2000®

Nominal .019 Thick

Length: 12'

25 Pcs./Ctn.

22.5 Lbs./Ctn.

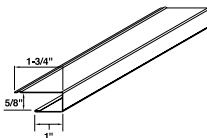

Note: For use with 5/8" vinyl soffit

White  
Almond  
Cameo  
Charcoal Grey  
Classic Cream  
Desert Sand  
Everest  
Harbor Grey  
Linen  
Montana Suede  
Musket Brown  
Pebblestone Clay

Rugged Canyon  
Sandtone  
Silver Grey  
Victorian Grey  
Wicker

78ALJ25

### J-Channel - 7/8"

Finish: Alupalure 2000®

Nominal .019" Thick

Length: 12' 0"

25 Pcs./Ctn.

26 Lbs./Ctn.

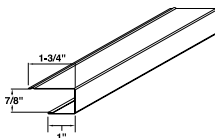

Note: For use with 5/8" or 3/4" vinyl siding and soffit.

White  
Almond  
Cameo  
Classic Cream  
Desert Sand  
Linen  
Montana Suede  
Pebblestone Clay  
Sandtone  
Wicker

SAT38

### "T" Channel - 3/8" 1 7/8" Face

Finish: Alupalure 2000®

Nominal .019 Thick

Length: 10'

10 Pcs./Ctn.

14 Lbs./Ctn.

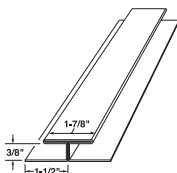

White  
Almond  
Black  
Cameo  
Classic Cream  
Dark Bronze  
Desert Sand  
Evergreen  
Jefferson Tan  
Linen

Montana Suede  
Musket Brown  
Pebblestone Clay  
Royal Brown  
Rugged Canyon  
Sandtone  
Silver Grey  
Terra Bronze  
Wicker

# Aluminum Soffit and Fascia Accessories

## Product Code/Description

## Color Availability

F8S25

**"F" Channel - 3/8"**  
**1 1/4" Face**

Finish: Alupalure 2000®  
Nominal .019 Thick  
Length: 12'  
25 Pcs./Ctn.  
37 Lbs./Ctn.

Use: 3/8" Soffit

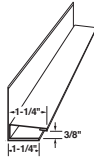

White  
Almond  
Black  
Brandy Wood  
Cameo  
Charcoal Grey  
Classic Cream  
Dark Bronze  
Desert Sand  
Everest  
Evergreen  
Harbor Grey  
Jefferson Tan  
Linen  
London Brown

Mahogany  
Montana Suede  
Musket Brown  
Pebblestone Clay  
Royal Brown  
Rugged Canyon  
Russet Red  
Sandtone  
Scottish Thistle  
Silver Grey  
Terra Bronze  
Tuscan Olive  
Victorian Grey  
Wicker

F12

**"F" Channel - 1/2"**  
**5/8" Face**

Finish: Alupalure 2000®  
Nominal .016 Thick  
Length: 12' 0"  
25 Pcs./Ctn.  
20 Lbs./Ctn.

Use: 1/2" Soffit

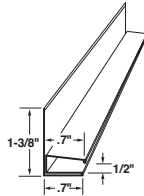

White  
Musket Brown

SF1625

**"F" Channel - 1/2"**  
**1" Face**

Finish: Alupalure 2000®  
Nominal .019 Thick  
Length: 12'  
25 Pcs./Ctn.  
37 Lbs./Ctn.

Use: 1/2" Soffit

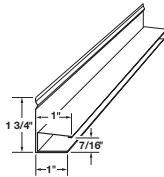

White  
Almond  
Cameo  
Desert Sand  
Linen  
Musket Brown  
Pebblestone Clay  
Royal Brown  
Sandtone  
Silver Grey  
Terra Bronze  
Wicker

SF58

**"F" Channel - 5/8"**  
**1" Face**

Finish: Alupalure 2000®  
Nominal .019 Thick  
Length: 12' 1"  
24 Pcs./Ctn.  
38 Lbs./Ctn.

For use with 5/8" Vinyl Soffit

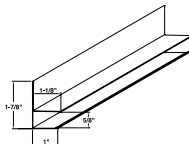

White  
Almond  
Cameo  
Pebblestone Clay  
Wicker

# Aluminum Soffit and Fascia Accessories

---

## Product Code/Description

---

WBTU

### Touch-Up Paint

(Bottled with brush)  
 1 Oz./Plastic Bottles  
 6/Ctn.  
 0.9 Lb./Ctn.





---

TN1250

### #15 Stainless Steel Trim Nails - 1-1/4"

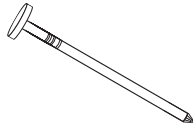
1 Lb./Ctn.



---

## Color Availability

---

White	Mahogany
Almond	Misty Shadow
Autumn Harvest	Montana Suede
Black	Musket Brown
Bronze	Natural Slate
Brandy Wood	Newport Bay
Cameo	Pebblestone Clay
Charcoal Grey	Quiet Willow
Classic Cream	Red Brick
Copper Penny	Royal Brown
Corn Silk	Rugged Canyon
Dark Bronze	Russet Red
Deep Granite	Sandtone
Desert Sand	Scottish Thistle
Everest	Silver Grey
Evergreen	Terra Bronze
English Wedgewood	Tuscan Olive
Harbor Grey	Victorian Grey
Jefferson Tan	Vineyard Grove
Linen	Wicker
London Brown	

---

Notes:

# Roof and Eave Ventilation Products

Product Code/Description

Color Availability

VAR  
**Vent-A-Ridge®**

Aluminum  
Length: 10'  
12 Pcs./Ctn.  
18 Sq. In. Net Free  
Ventilation/Lin. Ft.  
52 Lbs./Ctn.

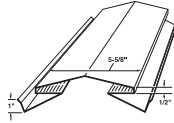

White  
Black  
Musket Brown

VAREP36  
**End Plug for VAR**

Solid Polymer  
36 Pcs./Ctn.  
5 Lbs./Ctn.

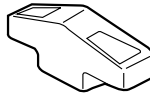

Black

VAS70  
**Vent-A-Strip (Model 70)**

Aluminum  
Length: 8'  
36 Pcs./Ctn.  
8.8 Sq. In. Net Free  
Ventilation/Lin. Ft.  
29 Lbs./Ctn.

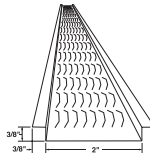

Mill

White  
Musket Brown

VAS79  
**Vent-A-Strip (Model 79)**

Aluminum  
Length: 8'  
36 Pcs./Ctn.  
9.9 Sq. In. Net Free  
Ventilation/Lin. Ft.  
33 Lbs./Ctn.

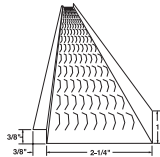

Notes:

# Gutter Coil

Description	Product Code	Thickness (nominal)	Width	Nominal Length	Target Coil Weight (+/-50 Lbs.)	Ft./Lb. Conversion	Color Availability
<b>Gutter Coil One-Side Finish Coat</b> 16" Center I.D.	GC11750	.027	11.750"	950	350	2.713	30° White (Medium Gloss)
	GC1175032	.032	11.750"	825	350	2.36	80° White (High Gloss)
	GC11875	.027	11.875"	940	350	2.684	Almond
	GC1187532	.032	11.875"	820	350	2.306	Black
	GC1300032*	.032	13.000"	750	350	2.133	Cameo
	GC15000	.027	15.000"	750	350	2.125	Charcoal Grey
	GC1500032	.032	15.000"	650	350	1.849	Classic Cream
	Product Code	Thickness (nominal)	Width	Length	Typical Coil Weight		
	SR1175032	.032	11.750"	150	63.6		Dark Bronze
	SR11875032	.032	11.875"	150	64.2		Desert Sand
	SR1300032	.032	13.000"	150	70.3		English Wedgewood
	SR1500032	.032	15.000"	100	54.8		Evergreen

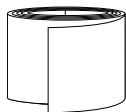

## Extended Lead Time Colors

*Available only in .032" standard and short roll*

*\*13" Gutter Coil not available in Extended Lead Time Colors.*

Autumn Harvest	Misty Shadow
Copper Penny	Mountain Blue
Deep Granite	Quiet Willow
Everest	Scottish Thistle
Harbor Grey	Tuscan Olive

Notes:

# Downspout Coil

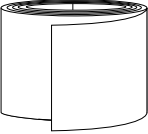
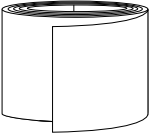
Description	Product Code	Thickness (nominal)	Width	Weight Target (Lbs.)	Color Availability
<p><b>2 x 3 Downspout Coil</b></p> <p>16" Center I.D. 3615' per roll / appx. 750# = 3615' appx.</p> 	DC10500	.019	10.500"	(±75) 750	30° White (Medium Gloss) 80° White (High Gloss) Almond Black Cameo Charcoal Grey Classic Cream Dark Bronze Desert Sand Evergreen Jefferson Tan Linen London Brown Montana Suede Musket Brown Pebblestone Clay Royal Brown Russet Red Sandtone Terra Bronze Victorian Grey Wicker
<p><b>3 x 4 Downspout Coil</b></p> <p>16" Center I.D. 1000 lb. = 3680' appx. 500 lb. = 1840' appx.</p> 	DC13750 DC1375500	.019	13.750"	(±75) 1000 500	

Notes:

# Gutter Accessories

---

## Product Code/Description

---

IBM5

### 5" Inside Box Miter

Nominal .019 Thick  
20 Pcs./Ctn.  
8 Lbs./Ctn.

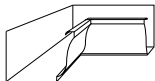



---

OBM5

### 5" Outside Box Miter

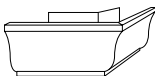
Nominal .019 Thick  
20 Pcs./Ctn.  
8 Lbs./Ctn.



---

ISM5

### 5" Inside Strip Miter

Nominal .032 Thick  
20 Pcs./Ctn.  
2.2 Lbs./Ctn.



---

OSM5

### 5" Outside Strip Miter

Nominal .032 Thick  
20 Pcs./Ctn.  
2.3 Lbs./Ctn.



---

## Color Availability

---

30° White  
(Medium Gloss)  
80° White  
(High Gloss)  
Almond  
Autumn Harvest  
Black  
Cameo  
Charcoal Grey  
Classic Cream  
Copper Penny  
Dark Bronze  
Deep Granite  
Desert Sand  
English Wedgewood  
Everest  
Evergreen  
Harbor Grey  
Jefferson Tan  
Linen  
London Brown  
Misty Shadow  
Montana Suede  
Mountain Blue  
Musket Brown  
Pebblestone Clay  
Quiet Willow  
Royal Brown  
Rugged Canyon  
Russet Red  
Sandtone  
Scottish Thistle  
Silver Grey  
Terra Bronze  
Tuscan Olive  
Victorian Grey  
Wicker

---

Notes:

# Gutter Accessories

---

## Product Code/Description

---

ISBAY5  
**5" Inside 45° Bay Miter**

Nominal .032 Thick  
 12 Pcs./Ctn.  
 1.1 Lbs./Ctn.

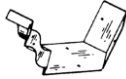

---

OSBAY5  
**5" Outside 45° Bay Miter**

Nominal .032 Thick  
 12 Pcs./Ctn.  
 1.1 Lbs./Ctn.

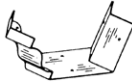

---

EC5L  
**5" Left End Caps**

Nominal .019 Thick  
 50 Pcs./Ctn.  
 2.6 Lbs./Ctn.



---

EC5R  
**5" Right End Caps**

Nominal .019 Thick  
 50 Pcs./Ctn.  
 2.6 Lbs./Ctn.



---

## Color Availability

---

30° White  
 (Medium Gloss/Paintable)  
 80° White  
 (High Gloss)  
 Almond  
 Black  
 Cameo  
 Dark Bronze  
 Musket Brown  
 Pebblestone Clay  
 Royal Brown  
 Wicker

---

30° White  
 (Medium Gloss)  
 80° White  
 (High Gloss)  
 Almond  
 Autumn Harvest  
 Black  
 Cameo  
 Charcoal Grey  
 Classic Cream  
 Copper Penny  
 Dark Bronze  
 Deep Granite  
 Desert Sand  
 English Wedgewood  
 Everest  
 Evergreen  
 Harbor Grey  
 Jefferson Tan  
 Linen  
 London Brown  
 Misty Shadow  
 Montana Suede  
 Mountain Blue  
 Musket Brown  
 Pebblestone Clay  
 Quiet Willow  
 Royal Brown  
 Rugged Canyon  
 Russet Red  
 Sandtone  
 Scottish Thistle  
 Silver Grey  
 Terra Bronze  
 Tuscan Olive  
 Victorian Grey  
 Wicker

# Gutter Accessories

---

## Product Code/Description

---

IBM6

### 6" Inside Box Miter

Nominal .019 Thick  
20 Pcs./Ctn.  
13 Lbs./Ctn.

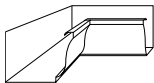

OBM6

### 6" Outside Box Miter

Nominal .019 Thick  
20 Pcs./Ctn.  
12 Lbs./Ctn.

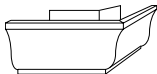

ISM6

### 6" Inside Strip Miter"

Nominal .032 Thick  
20 Pcs./Ctn.  
3.4 Lbs./Ctn.



OSM6

### 6" Outside Strip Miter

Nominal .032 Thick  
20 Pcs./Ctn.  
3.2 Lbs./Ctn.



---

## Color Availability

---

30° White  
(Medium Gloss)  
80° White  
(High Gloss)  
Almond  
Autumn Harvest  
Black  
Cameo  
Classic Cream  
Charcoal Grey  
Copper Penny  
Dark Bronze  
Deep Granite  
Desert Sand  
English Wedgewood  
Everest  
Evergreen  
Harbor Grey  
Jefferson Tan  
Linen  
London Brown  
Misty Shadow  
Montana Suede  
Mountain Blue  
Musket Brown  
Pebblestone Clay  
Quiet Willow  
Royal Brown  
Rugged Canyon  
Russet Red  
Sandtone  
Scottish Thistle  
Silver Grey  
Terra Bronze  
Tuscan Olive  
Victorian Grey  
Wicker

Notes:

# Gutter Accessories

---

## Product Code/Description

---

ISBAY6  
**6" Inside 45° Bay Miter**  
 Nominal .032 Thick  
 12 Pcs./Ctn.  
 2 Lbs./Ctn.

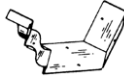



---

OSBAY6  
**6" Outside 45° Bay Miter**  
 Nominal .032 Thick  
 12 Pcs./Ctn.  
 2 Lbs./Ctn.

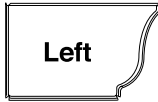

---

EC6L  
**6" Left End Caps**  
 Nominal .019 Thick  
 50 Pcs./Ctn.  
 3.6 Lbs./Ctn.



---

EC6R  
**6" Right End Caps**  
 Nominal .019 Thick  
 50 Pcs./Ctn.  
 3.6 Lbs./Ctn.



---

## Color Availability

---

30° White  
 (Medium Gloss/Paintable)  
 80° White  
 (High Gloss)

---

30° White (Medium Gloss)	Linen
80° White (High Gloss)	London Brown
Almond	Misty Shadow
Autumn Harvest	Montana Suede
Black	Mountain Blue
Cameo	Musket Brown
Classic Cream	Pebblestone Clay
Charcoal Grey	Quiet Willow
Copper Penny	Royal Brown
Dark Bronze	Rugged Canyon
Deep Granite	Russet Red
Desert Sand	Sandtone
English Wedgewood	Scottish Thistle
Everest	Silver Grey
Evergreen	Terra Bronze
Harbor Grey	Tuscan Olive
Jefferson Tan	Victorian Grey
	Wicker

---

Notes:

# Gutter Accessories

---

## Product Code/Description

---

R0T2X3

**Outlet Tubes**

2" x 3" Rectangular  
30 Pcs./Ctn.  
1.9 Lbs./Ctn.

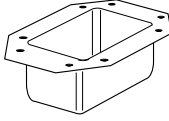

R0T3X4

**Outlet Tubes**

3" x 4" Rectangular  
50 Pcs./Ctn.  
3.9 Lbs./Ctn.

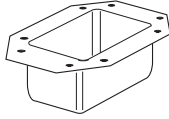

SP7

**7" Spike**

500 Pcs./Ctn.  
17.3 Lbs./Ctn.

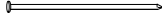

SP8

**8" Spike**

500 Pcs./Ctn.  
19 Lbs./Ctn.



FE5

**5" Ferrule**

500 Pcs./Ctn.  
5 Lbs./Ctn..

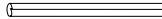

FE6

**6" Ferrule**

500 Pcs./Ctn.  
5.8 Lbs./Ctn.

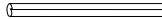

---

## Color Availability

---

Mill Finish

30° White  
(Medium Gloss)  
80° White  
(High Gloss)

Mill Finish

Notes:

# Gutter and Downspout Coil Accessories

---

Product Code/Description

---

---

Color Availability

---

AM5HID

## Aluminum 5" Hidden Hanger

Nominal .065 Thick

100 Pcs./Ctn.

6 Lbs./Ctn.



Mill Finish

---

AM5ZIP500

## Aluminum 5" Zip Hanger

500 Pcs./Ctn.

37 Lbs./Ctn.

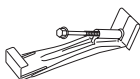

Mill Finish

---

AM6ZIP

## Aluminum 6" Zip Hanger

50 Pcs./Ctn.

5 Lbs./Ctn.

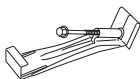

Mill Finish

---

GS50Z

## Gutter Seal

24 Tubes./Ctn.

8 Lbs./Ctn.

5 oz.

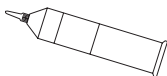

Mill Finish

---

GSW40Z J1

## Gutter Seal

12 Tubes./Ctn.

3.75 Lbs./Ctn.

4 oz.

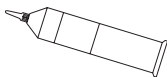

White

---

ASDIV

## Valley Water Diverter

30 Pcs./Ctn.

1.6 Lbs./Ctn.

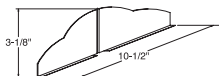

White

---

# Downspouts and Accessories

---

## Product Code/Description

---



---

## Color Availability

---

DS2X3  
**2" x 3" Downspout**  
**Length: 10'**

.019 nominal  
 10 Pcs./Ctn.  
 26 Lbs./Ctn.

*Note: Minimum order-one carton.*

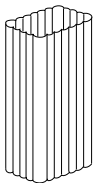

30° White  
 (Medium Gloss)  
 80° White  
 (High Gloss)  
 Almond  
 Black  
 Cameo  
 Charcoal Grey  
 Classic Cream  
 Dark Bronze  
 Desert Sand  
 Evergreen  
 Harbor Grey  
 Jefferson Tan  
 Linen  
 London Brown  
 Montana Suede  
 Musket Brown  
 Pebblestone Clay  
 Royal Brown  
 Rugged Canyon  
 Russet Red  
 Sandtone  
 Scottish Thistle  
 Silver Grey  
 Terra Bronze  
 Tuscan Olive  
 Victorian Grey  
 Wicker

---

E2X3A  
**2" x 3" Elbow, Style A**

.019 nominal  
 30 Pcs./Ctn.  
 7 Lbs./Ctn.

*Note: Minimum order-one carton.*

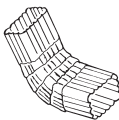

75°

### Extended Lead Time Colors

Autumn Harvest	Misty Shadow
Brandy Wood	Mountain Blue
Corn Silk	Natural Slate
Copper Penny	Newport Bay
Deep Granite	Portsmouth Blue
English Wedgewood	Quiet Willow
Everest	Red Brick
Lakeshore Fern	Sage
Mahogany	Vineyard Grove

---

E2X3B  
**2" x 3" Elbow, Style B**

.019 nominal  
 30 Pcs./Ctn.  
 7 Lbs./Ctn.

*Note: Minimum order-one carton.*

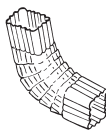

75°

---

Notes:

# Downspouts and Accessories

---

## Product Code/Description

---

E2X3A30  
**2" x 3" Elbow, 30° Style A**  
 .019 nominal  
 30 Pcs./Ctn.  
 7 Lbs./Ctn.

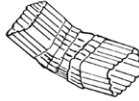

*Use: short overhang / ledges*

---

## Color Availability

---

30° White (Medium Gloss)	Evergreen Linen
80° White (High Gloss)	Musket Brown Pebblestone Clay
Almond	Royal Brown
Black	Sandtone
Cameo	Terra Bronze
Classic Cream	Victorian Grey
Dark Bronze	Wicker
Desert Sand	

---

DS2X38  
**2" x 3" Downspout**

.019 nominal  
 Length: 8'  
 10 Pcs./Ctn.  
 20 Lbs./Ctn.

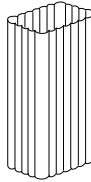

*Note: Minimum order-one carton.*

---

30° White (Medium Gloss)

---

Notes:

# Downspouts and Accessories

## Product Code/Description

LEDGE152X3  
**2" x 3" Downspout  
 with 1.5" Offset**

.019 nominal  
 25 Pcs./Ctn.  
 6 Lbs./Ctn.



LEDGE302X3  
**2" x 3" Downspout  
 with 3" Offset**

.019 nominal  
 20 Pcs./Ctn.  
 6 Lbs./Ctn.



DS3X4  
**3" x 4" Downspout**

.019 nominal  
 Length: 10'  
 10 Pcs./Ctn.  
 34 Lbs./Ctn.

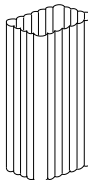

*Note: Minimum order-one carton.*

E3X4A  
**3" x 4" Elbow, Style A**

.019 nominal  
 20 Pcs./Ctn.  
 7 Lbs./Ctn.

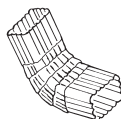

75°

*Note: Minimum order-one carton.*

E3X4B  
**3" x 4" Elbow, Style B**

.019 nominal  
 20 Pcs./Ctn.  
 8 Lbs./Ctn.

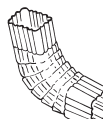

75°

*Note: Minimum order-one carton.*

## Color Availability

30° White (paintable)  
 80° White  
 Musket Brown  
 Pebblestone Clay

30° White  
 (Medium Gloss)  
 80° White  
 (High Gloss)  
 Almond  
 Black  
 Cameo  
 Charcoal Grey  
 Classic Cream  
 Dark Bronze  
 Desert Sand  
 Evergreen  
 Harbor Grey  
 Jefferson Tan  
 Linen  
 London Brown  
 Montana Suede  
 Musket Brown  
 Pebblestone Clay  
 Royal Brown  
 Rugged Canyon  
 Russet Red  
 Sandtone  
 Scottish Thistle  
 Silver Grey  
 Terra Bronze  
 Tuscan Olive  
 Victorian Grey  
 Wicker

## Extended Lead Time Colors

Autumn Harvest	Misty Shadow
Brandy Wood	Mountain Blue
Corn Silk	Natural Slate
Copper Penny	Newport Bay
Deep Granite	Portsmouth Blue
English	Quiet Willow
Wedgewood	Red Brick
Everest	Sage
Lakeshore Fern	Vineyard Grove
Mahogany	

# Downspouts and Accessories

---

## Product Code/Description

---

E3X4A30  
**3" x 4" Elbow, 30° Style A**  
 .019 nominal  
 20 Pcs./Ctn.  
 8 Lbs./Ctn.

*Use: short overhang / ledges*

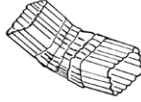

---

## Color Availability

---

30° White (Medium Gloss)	Evergreen
80° White (High Gloss)	Linen
Almond	Musket Brown
Black	Pebblestone Clay
Cameo	Royal Brown
Classic Cream	Sandtone
Dark Bronze	Terra Bronze
Desert Sand	Victorian Grey
	Wicker

---

DS3X48  
**3" x 4" Downspout**

.019 nominal  
 Length: 8'  
 10 Pcs./Ctn.  
 29 Lbs./Ctn.

*Note: Minimum order-one carton.*

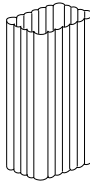



---

30° White  
(Medium Gloss)

---

LEDGE203X4  
**3" x 4" Downspout with  
 2" Offset**

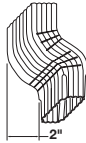
.019 nominal  
 12 Pcs./Ctn.  
 5.5 Lbs./Ctn.





---

30° White (paintable)  
 80° White  
 Musket  
 Pebblestone Clay

---

LEDGE403X4  
**3" x 4" Downspout with  
 4" Offset**

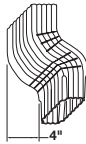
.019 nominal  
 12 Pcs./Ctn.  
 5.7 Lbs./Ctn.



---

LEDGE603X4  
**3" x 4" Downspout with  
 6" Offset**

.019 nominal  
 12 Pcs./Ctn.  
 6.5 Lbs./Ctn.



# Gutter and Downspout Coil Accessories

## Product Code/Description

DPB

### Downspout Pipe Band -Universal

(Fits 2" x 3" or 3" x 4" Downspout)

100 Pcs./Ctn.

Packaged Flat

3.6 Lbs./Ctn.



GR1

### 1/8" Bind Pop Rivets\*

100 Pcs./Bag

10 Bags/Box

1.25 Lbs./Box

\*Not available in J0 or J1.



GZS8

### #8 x 1/2" Zip Screws

100 Pcs./Bag

10 Bags/Ctn.

3.8 Lbs./Ctn.



GCTU

### Touch Up Paint (Aerosol)

12 Ozs./Can

12 Cans/Ctn.

12.6 Lbs./Ctn.

\*Extended Lead Time.



GCTU1

### Touch Up Paint (Aerosol Single Can)

12 Ozs./Can

1 Can/Ctn.

1.2 Lb./Ctn.

\*Extended Lead Time.



## Color Availability

30° White  
(Medium Gloss)

80° White  
(High Gloss)

Almond

Autumn Harvest

Black

Brandy Wood

Cameo

Charcoal Grey

Classic Cream

Copper Penny

Corn Silk

Dark Bronze

Deep Granite

Desert Sand

English Wedgewood

Everest

Evergreen

Harbor Grey

Jefferson Tan

Linen

London Brown

Mahogany

Misty Shadow

Montana Suede

Mountain Blue

Musket Brown

Natural Slate

Newport Bay

Pebblestone Clay

Portsmouth Blue

Quiet Willow

Red Brick

Royal Brown

Rugged Canyon

Russet Red

Sage

Sandtone

Scottish Thistle

Silver Grey

Terra Bronze

Tuscan Olive

Victorian Grey

Vineyard Grove

Wicker

30° White  
(Medium Gloss)

80° White  
(High Gloss)

Almond

Autumn Harvest

Black

Brandy Wood

Cameo

Charcoal Grey

Classic Cream

Copper Penny

Corn Silk

Dark Bronze

Deep Granite

Desert Sand

English Wedgewood

Everest

Evergreen

Harbor Grey

Jefferson Tan

Lakeshore Fern

Linen

London Brown

Mahogany

Misty Shadow

Montana Suede

Mountain Blue

Musket Brown

Natural Slate

Newport Bay

Pebblestone Clay

Portsmouth Blue

Quiet Willow

Red Brick

Royal Brown

Rugged Canyon

Russet Red

Sage

Sandtone

Scottish Thistle

Silver Grey

Terra Bronze

Tuscan Olive

Victorian Grey

Vinyard Grove

Wicker

# Metal Accessories Program

for Fiber Cement

James Hardie Colors

Category	Product Code	Description	Color Availability	
<b>Gutter Coil</b>	GC1175032	.032 x 11.750 Gutter Coil	J0/04	White
	GC1187532	.032 x 11.875 Gutter Coil	620	Autumn Tan
	GC1500032	.032 x 15.000 Gutter Coil	238	Cobblestone
<b>Downspouts and Elbows</b>	DS3X4	3 x 4 Downspout	625	Khaki Brown
	E3X4A	A Elbow 75"	259	Monterey Taupe
	E3X4B	B Elbow 75"	53	Navajo Beige (Almond)
	DPB	Downspout Pipe Bands	851	Sail Cloth
	GCTU	Spray Paint Carton	297	Sandstone Beige
	GCTU1	Spray Paint Can	626	Timber Bark
<b>Gutter Accessories</b>	IBM5	5" Inside Box Miter	581	Woodstock Brown
	OBM5	5" Outside Box Miter		
	ISM5	5" Inside Strip Miter		
	OSM5	5" Outside Strip Miter		
	EC5L	5" End Cap Left		
	EC5R	5" End Cap Right		
	IBM6	6" Inside Box Miter		
	OBM6	6" Outside Box Miter		
	ISM6	6" Inside Strip Miter		
	OSM6	6" Outside Strip Miter		
<b>Soffit</b>	SAS12316	Endurance T4 Soffit Solid		
	LCAS12316	Endurance T4 Soffit Center Vent		
	LFAS12316	Endurance T4 Soffit Full Vent		
	F438425	3/8" J-Channel		

Notes:



# Round Downspout Program

---

## Product Code/Description

---

---

## Color Availability

---

### Downspout, Elbow, Offsets

DSR4

#### 4" Smooth Round Downspout

Nominal .024 Thick

5 Pcs./Ctn.

21 Lbs./Ctn.



ESR4

#### 4" Smooth Round Elbow 75°

Nominal .024 Thick

20 Pcs./Ctn.

11 Lbs./Ctn.



OSR420

#### 4" Smooth Round - 2' Offset

Nominal .024 Thick

10 Pcs./Ctn.

5 Lbs./Ctn.



OSR440

#### 4" Smooth Round - 4' Offset

Nominal .024 Thick

10 Pcs./Ctn.

6 Lbs./Ctn.

OSR460

#### 4" Smooth Round - 6' Offset

Nominal .024 Thick

10 Pcs./Ctn.

6.5 Lbs./Ctn.

30 Gloss White

80 Gloss White

Almond

Black

Cameo

Classic Cream

Dark Bronze

Dessert Sand

Linen

Montana Suede

Musket Brown

Pebblestone Clay

Royal Brown

Sandtone

Wicker

# Envoy® Sectional Gutter

## 5" Gutter and Accessories

---

### Product Code/Description

---

OG16A

#### Envoy Sectional 5" OG Gutter

Nominal .032 Thick  
Length: 16'  
10 Pcs./Ctn.  
160'/Ctn.  
80 Lbs./Ctn.

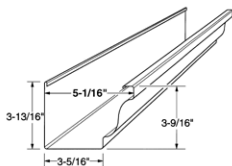

---

### Color Availability

---

80 White  
Almond  
Desert Sand  
Evergreen  
Musket Brown  
Pebblestone Clay  
Sandtone  
Terra Bronze  
Victorian Grey

OG21A

#### Envoy Sectional 5" OG Gutter

Nominal .032 Thick  
Length: 21'  
10 Pcs./Ctn.  
210'/Ctn.  
105 Lbs./Ctn.

OG33A

#### Envoy Sectional 5" OG Gutter

Nominal .032 Thick  
Length: 33'  
6 Pcs./Ctn.  
198'/Ctn.  
103 Lbs./Ctn.

OG26

#### Envoy Sectional 5" OG Gutter

Nominal .032 Thick  
Length: 26'  
6 Pcs./Ctn.  
156'/Ctn.  
81 Lbs./Ctn.

OG37A

#### Envoy Sectional 5" OG Gutter

Nominal .032 Thick  
Length: 37'  
6 Pcs./Ctn.  
222'/Ctn.  
115 Lbs./Ctn.

# Envoy® Sectional Gutter

## 5" Gutter Accessories

---

### Product Code/Description

---

OG155

#### 5" End Caps

Nominal .024 Thick  
25 R and 25 L  
25 Sets./Ctn.  
50 Pcs./Ctn.  
3.3 Lbs./Ctn.

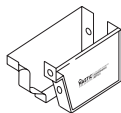

---

### Color Availability

---

80 White  
Almond  
Desert Sand  
Evergreen  
Musket Brown  
Pebblestone Gray  
Sandtone  
Terra Bronze  
Victorian Grey

---

OG25

#### Neoprene Expansion Joint

12 Pcs./Ctn.  
4 Lbs./Ctn.

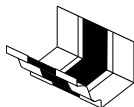

Mill

---

OG91

#### Snug-Fit Hanger

Nominal .081 Thick  
100 Pcs./Ctn.  
11.2 Lbs./Ctn.

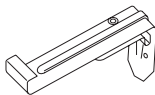

Mill

---

OG101

#### Combination Hanger

Nominal .081 Thick  
100 Pcs./Ctn.  
8.4 Lbs./Ctn.

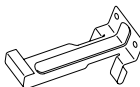

Mill

---

OG111

#### Strap Hanger

Nominal .081 Thick  
100 Pcs./Ctn.  
9.6 Lbs./Ctn.

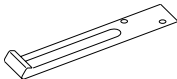

Mill

---

Notes:

# Envoy® Sectional Gutter

## 5" Gutter Accessories

---

### Product Code/Description

---



---

### Color Availability

---

OG12R1

#### Bar Hanger

Nominal .081 Thick  
100 Pcs./Ctn.  
7.4 Lbs./Ctn.



Mill

---

OG131

#### Roof Hanger

Nominal .062 Thick  
100 Pcs./Ctn.  
13 Lbs./Ctn.



Mill

---

OG141

#### Combination Strap Hanger

Nominal .081 Thick  
100 Pcs./Ctn.  
12 Lbs./Ctn.

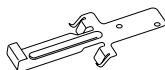

Mill

---

RT312

#### Roof Apron, Rectangular

Nominal .032 Thick  
Length: 12"  
20 Pcs./Ctn.  
320'/Ctn.  
47 Lbs./Ctn.

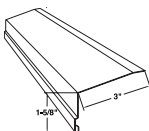

80 White  
Almond  
Desert Sand  
Evergreen  
Musket Brown  
Pebblestone Clay  
Sandtone  
Terra Bronze  
Victorian Grey

---

RT412

#### Fascia Apron, Rectangular

Nominal .032 Thick  
Length: 12"  
20 Pcs./Ctn.  
240'/Ctn.  
15 Lbs./Ctn.

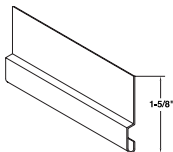

80 White  
Almond  
Desert Sand  
Evergreen  
Musket Brown  
Pebblestone Clay  
Sandtone  
Terra Bronze  
Victorian Grey

---

Notes:

# Envoy® Sectional Gutter

## 6" Gutter and Accessories

---

### Product Code/Description

---

OG21A6

#### **Envoy Sectional 6" OG Gutter**

Nominal .032 Thick  
Length: 21'  
6 Pcs./Ctn.  
126'/Ctn.  
79 Lbs./Ctn.

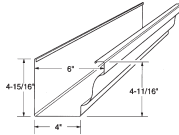

OG37A6

#### **Envoy Sectional 6" OG Gutter**

Nominal .032 Thick  
Length: 37'  
4 Pcs./Ctn.  
148'/Ctn.  
95 Lbs./Ctn.

---

OG1565

#### **6" End Caps**

Nominal .024 Thick  
25 Sets/Ctn.  
50 Pcs./Ctn.  
4.5 Lbs./Ctn.

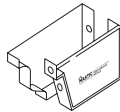

---

### Color Availability

---

80 White  
Almond  
Desert Sand  
Evergreen  
Musket Brown  
Pebblestone Clay  
Sandtone  
Terra Bronze  
Victorian Grey

---

80 White  
Almond  
Desert Sand  
Evergreen  
Musket Brown  
Pebblestone Clay  
Sandtone  
Terra Bronze  
Victorian Grey

---

Notes:

# Envoy® Sectional Gutter

## 6" Gutter and Accessories

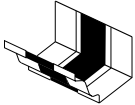
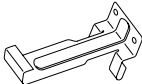
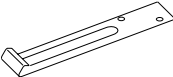
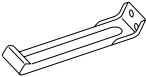
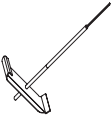
Product Code/Description		Color Availability
OG256 <b>Neoprene Expansion Joint</b> 12 Pcs./Ctn. 5 Lbs./Ctn.		Mill
OG1061 <b>Combination Hanger</b> Nominal .081 100 Pcs./Ctn. 9.4 Lbs./Ctn.		Mill
OG1161 <b>Strap Hanger</b> Nominal .081 Thick 100 Pcs./Ctn. 11 Lbs./Ctn.		Mill
OG12R61 <b>Bar Hanger</b> Nominal .081 Thick 100 Pcs./Ctn. 8.3 Lbs./Ctn.		Mill
OG1361 <b>Roof Hanger</b> Nominal .062 Thick 100 Pcs./Ctn. 13 Lbs./Ctn.		Mill

Notes:

# Envoy® Sectional Gutter

## Downspouts and Accessories

---

### Product Code/Description

---

RT34  
**3" x 4" Rectangular  
 Corrugated Downspout**

Nominal .024 Thick  
 Length: 10'  
 10 Pcs./Ctn.  
 100'/Ctn.  
 43 Lbs./Ctn.

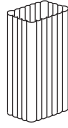

---

RTA74  
**3" x 4" Style "A"  
 Rectangular Elbow**

Nominal .024 Thick  
 Degree: 75°  
 20 Pcs./Ctn.  
 9 Lbs./Ctn.

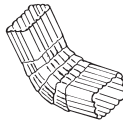

---

RTB74  
**3" x 4" Style "B"  
 Rectangular Elbow**

Nominal .024 Thick  
 Degree: 75°  
 20 Pcs./Ctn.  
 10 Lbs./Ctn.

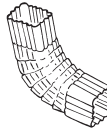

---

RTA3  
**Downspout Clip**

(For 3" x 4" Downspout)  
 Nominal .024 Thick  
 100 Pcs./Ctn.  
 2.8 Lbs./Ctn.

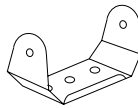

---

RT24F  
**3" x 4" Rectangular  
 Eave Tube**

Nominal .032 Thick  
 18 Pcs./Ctn.  
 3 Lbs./Ctn.

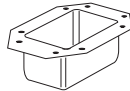

---

RT241  
**3" x 4" Rectangular  
 Eave Tube**

Nominal .038 Thick  
 18 Pcs./Ctn.  
 3.1 Lbs./Ctn.

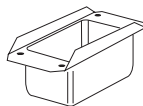

---

### Color Availability

---

30 White  
 80 White  
 Almond  
 Desert Sand  
 Evergreen  
 Musket Brown  
 Pebblestone Clay  
 Sandtone  
 Terra Bronze  
 Victorian Grey

---

30 White	Linen
80 White	Musket Brown
Almond	Pebblestone Clay
Black	Royal Brown
Cameo	Sandtone
Classic Cream	Terra Bronze
Dark Bronze	Victorian Grey
Desert Sand	Wicker
Evergreen	

---

Mill

---

Mill

# Envoy® Sectional Gutter

## Downspouts and Accessories

### Product Code/Description

RT2

#### 2" x 3" Rectangular Corrugated Downspout

Nominal .024 Thick  
Length: 10'  
10 Pcs./Ctn.  
100'/Ctn.  
33 Lbs./Ctn.

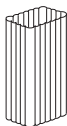

#### 2" x 3" Style "A" Rectangular Elbow

RTA4 (80 White High Gloss Only)  
Nominal .024 Thick  
Degree: 45°  
30 Pcs./Ctn.  
8 Lbs./Ctn.

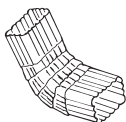

RTA7

Nominal .024 Thick  
Degree: 75°  
30 Pcs./Ctn.  
9 Lbs./Ctn.

RTB7

#### 2" x 3" Style "B" Rectangular Elbow

Nominal .024 Thick  
Degree: 75°  
30 Pcs./Ctn.  
9 Lbs./Ctn.

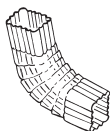

R0T2X3

#### 2" x 3" Rectangular Eave Tube

Nominal .024 Thick  
30 Pcs./Ctn.  
1.9 Lbs./Ctn.

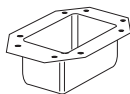

RTA2

#### Downspout Clip

(For 2" x 3" Downspout)  
Nominal .024 Thick  
100 Pcs./Ctn.  
1.7 Lbs./Ctn.

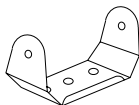

RT235

#### Downspout Anchor Clip with Screw

50 Sets/Ctn.  
3.2 Lbs./Ctn.

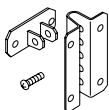

### Color Availability

30 White  
80 White  
Almond  
Desert Sand  
Evergreen  
Musket Brown  
Pebblestone Clay  
Sandtone  
Terra Bronze  
Victorian Grey

Mill

30 White  
80 White  
Almond  
Black  
Cameo  
Clasic Cream  
Dark Bronze  
Desert Sand  
Evergreen

Linen  
Musket Brown  
Pebblestone Clay  
Royal Brown  
Sandtone  
Terra Bronze  
Victorian Grey  
Wicker

Mill

# Leaf Relief® 5"

## Gutter Protection Systems

---

### Product Code/Description

---

D11500  
**DuoPro 5" Dual Layer  
Microfiltration -  
Continuous Hanger**

Nominal .019 Thick  
Length: 7'6"  
24 Pcs./Ctn.  
180'/Ctn.  
47 Lbs./Ctn.

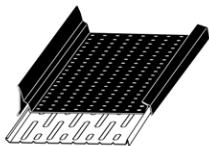

*Note: 200 screws/carton. use Leaf Relief DuoPro 5" Dual Layer Universal Corner or Access Panel Kit UA11500*

---

### Color Availability

---

00 No Color

---

UA11500  
**DuoPro 5" Dual Layer  
Microfiltration Universal  
Inside/Outside Corner or  
Access Panel Kit**

Nominal .019 Thick  
10 Corners or 20 Access  
Panels/Ctn  
5Lbs./Ctn.

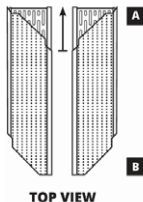

*Note: Use with D11500 DuoPro 5" Dual Layer Microfiltration Continuous Hanger. Universal Inside/Outside/Access Panel functions as either one corner or two Access Panels*

00 No Color

---

SN5200  
**5" Continuous Hanger**

Nominal .019 Thick  
Length: 7'6"  
48 Pcs./Ctn.  
360'/Ctn.  
59.4 Lbs./Ctn.

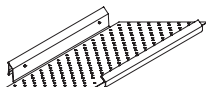

*Note: 300 screws/carton. Use Leaf Relief corner kits OC5220/IC5220*

00 No Color

---

SN5200BG  
**5" Box Gutter  
Continuous Hanger**

Length 7'6"  
360'/Ctn.  
63 Lbs./Ctn.  
300 screws included.

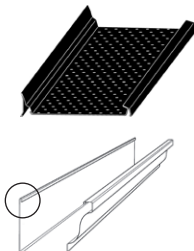

*Note: use Leaf Relief corner kit UA5200BG Universal Inside/Outside Corner Access Panel*

Black

# Leaf Relief® 5"

## Gutter Protection Systems

---

### Product Code/Description

---

TP5300

#### 5" Classic

Nominal .019 Thick  
Length: 10'  
32 Pcs./Ctn.  
320'/Ctn.  
48.6 Lbs./Ctn.



---

### Color Availability

---

00 No Color

---

TP53ZIP

#### 5" Zip

Nominal .019 Thick  
Length: 10'  
32 Pcs./Ctn.  
320'/Ctn.  
51.8 Lbs./Ctn.

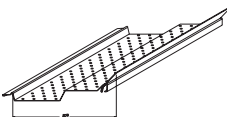

---

00 No Color

---

APSN52

#### 5" Leaf Relief Access Panel

Nominal .019 Thick  
Length: 1'6"  
20 Pcs./Ctn.  
30'/Ctn.  
5.8 Lbs./Ctn.

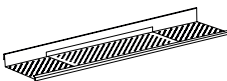

---

00 No Color

---

TP5100Q

#### 5" Adjustable

Nominal .019 Thick  
Length: 7'6"  
16 Pcs./Ctn.  
120'/Ctn.  
22 Lbs./Ctn.

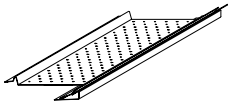

---

00 No Color

---

TPC5100

#### 5" Adjustable Copper

Nominal .017 Thick  
Length: 7'6"  
16 Pcs./Ctn.  
120'/Ctn.  
71.6 Lbs./Ctn.  
200 Copper screws included.

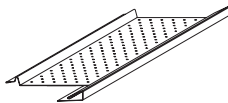

---

0C Copper

*Use only with K or OG-style copper gutters.*

*\*Special order. One Carton Minimum. Call for price and lead time.*

# Leaf Relief® 5"

## Gutter Protection Systems

---

### Product Code/Description

---

HR5400

#### 5" Half-Round

Nominal .024" Thick  
Length: 7'6"  
16 Pcs./Ctn.  
120'/Ctn.  
22.6 Lbs./Ctn.

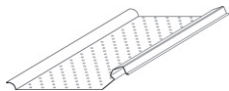

---

HRC5400

#### 5" Half Round Copper

Nominal .017 Thick  
Length: 7'6"  
16 Pcs./Ctn.  
120'/Ctn.  
56.5 Lbs./Ctn.  
200 Copper screws included.



*Use only with 5" Half-Round copper gutters.*

*\*Special order. One Carton Minimum. Call for price and lead time.*

---

OC5220

#### 5" Outside Corners

Nominal .019 Thick  
20 complete corners/Ctn  
3.4 Lbs./Ctn.

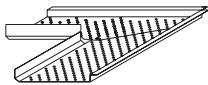

*Use with SN5200S, TP5100Q, TP5300, TP53ZIP*

---

IC5220

#### 5" Inside Corners

Nominal .019 Thick  
20 complete corners/Ctn.  
3.4 Lbs./Ctn.

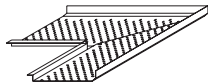

*Use with SN5200S, TP5100Q, TP5300, TP53ZIP*

---

UA5200BG

#### 5" box Gutter Continuous Hanger Universal Inside/Outside Corner/Access Panel Kit

10 corners or 20 access panels per carton  
4 Lbs./Ctn.

---

### Color Availability

---

00 No Color

---

0C Copper

---

00 No Color

---

00 No Color

---

00 No Color

# Leaf Relief® 6"

## Gutter Protection Systems

---

### Product Code/Description

---

---

### Color Availability

---

D11600

#### DuoPro 6" Dual Layer Microfiltration - Continuous Hanger

Product Specs Coming  
Jan 2020. See digital  
spec guide.

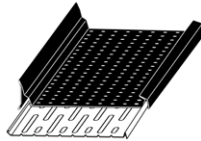

00 No Color

*Note: use Leaf Relief DuoPro 6" Dual Layer Universal Corner  
or Access Panel Kit UA11600. Universal Inside/Outside/Access  
Panel functions as either one corner or two Access Panels*

---

UA11600

#### DuoPro 6" Dual Layer Microfiltration Universal Inside/Outside Corner or Access Panel Kit

Nominal .019 Thick  
Product Specs Coming January  
2020. See digital spec guide.

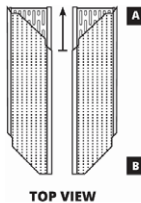

00 No Color

*Note: Use with D11600 DuoPro 6" Dual Layer Microfiltration  
Continuous Hanger. Universal Inside/Outside/Access Panel  
functions as either one corner or two Access Panels.*

---

SN6200

#### 6" Continuous Hanger

Nominal .019 Thick  
Length: 7' 6"  
34 Pcs./Ctn.  
255'/Ctn.  
49.4 Lbs./Ctn.

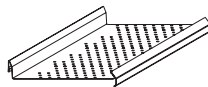

00 No Color

*Note: 300 screws/carton. Use Leaf Relief corner kits OC6220/IC6220*

---

SN6200BG

#### 6" Box Gutter Continuous Hanger

Nominal .019 Thick  
Product Specs Coming  
January 2020. See  
digital spec guide.

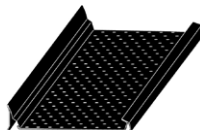

00 No Color

*Note: use Leaf Relief Universal  
Corner or Access Panel Kit  
UA6200BG Universal Inside/  
Outside/Access Panel. Universal  
Inside/Outside/Access Panel  
either functions as one corner or  
two Access Panels.*

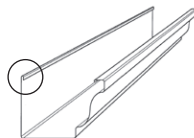

# Leaf Relief® 6"

## Gutter Protection Systems

---

### Product Code/Description

---

UA6200BG

#### **6" Box Gutter Universal Inside/Outside Corner or Access Panel Kit**

Nominal .019 Thick  
Product Specs Coming  
January 2020. See digital  
spec guide.

*Note: use with SN6200BG 6" Box Gutter Continuous Hanger.*

---

### Color Availability

---

00 No Color

---

TP6300

#### **6" Classic**

Nominal .019 Thick  
Length: 10'  
32 Pcs./Ctn.  
320'/Ctn.  
55.4 Lbs./Ctn.

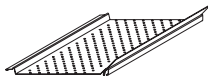

---

00 No Color

---

TP63ZIP

#### **6" Zip**

Nominal .019 Thick  
Length: 10'  
32 Pcs./Ctn.  
320'/Ctn.  
57.6 Lbs./Ctn.

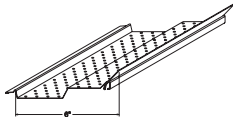

*(For use over OG1061, OG12R61, zip hangers)*

---

00 No Color

---

TPC6100

#### **6" Adjustable Copper**

Nominal .017 thick  
Length: 7'6"  
16 Pcs./Ctn.  
120'/Ctn.  
75.0 Lbs./Ctn.  
200 Copper screws included.

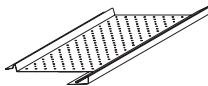

*Use only with K or OG-style copper gutters.*

*\*Special Order. One Carton Minimum. Call for price and lead time.*

---

00 Copper

---

APSN62

#### **6" Leaf Relief Access Panel**

Nominal .019 thick  
Length: 1'6"  
20 Pcs./Ctn.  
30'/Ctn.  
6.6 Lbs./Ctn.

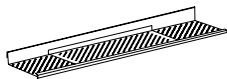

---

00 No Color

# Leaf Relief® 6"

## Gutter Protection Systems

---

### Product Code/Description

---

HR6400

#### 6" Half Round

Nominal .024 Thick  
Length: 7'6"  
16 Pcs./Ctn.  
120'/Ctn.  
25.4 Lbs./Ctn.

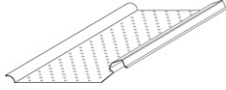

---

### Color Availability

---

00 No Color

---

HRC6400

#### 6" Half Round Copper

Nominal .017 Thick  
Length: 7'6"  
16 Pcs./Ctn.  
120'/Ctn.  
63.0 Lbs./Ctn.  
200 Copper screws included.

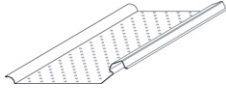

*Use only with 6" Half-Round copper gutters.*

---

0C Copper

---

OC6220

#### 6" Leaf Relief Outside Corners

Nominal .019 Thick  
20 complete corners/Ctn.  
3.8 Lbs./Ctn.

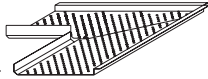

*Use: SN6200S, TP6300*

---

00 No Color

---

IC6220

#### 6" Leaf Relief Inside Corners

Nominal .019 Thick  
20 complete corners/Ctn.  
3.8 Lbs./Ctn.

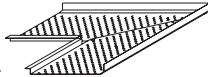

*Use: SN6200S, TP6300*

---

00 No Color

---

Notes:

# Leaf Relief®

## Gutter Protection Systems

---

### Product Code/Description

---

SN7200S 00

#### **7" Leaf Relief Continuous Hanger w/Screws**

7'6" Length  
200 Screws/Ctn.  
24 Pcs./Ctn.  
47 Lbs./Ctn.

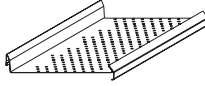

---

### Color Availability

---

00 No Color

---

SC9X150

#### **#9 x 1-1/2" Hex-Head Coated Screw with Gasket**

1000/Ctn.  
100/Pkg.  
10 Pkg./Ctn.  
11.5 Lbs./Ctn.



*(For use with SN5200S, SN6200S, and SN7200S Systems)*

---

SQ6X038

#### **#6 x 3/8" Stainless Steel Screw Pan Head with Square Drive Slot**

1000/Ctn.  
100/Pkg.  
10 Pkg./Ctn.  
2 Lbs./Ctn

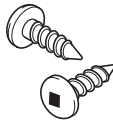

Mill Finish

*(For use with TP5100Q, TP5300, HR5400, HR6400, and TP6300 Systems)*

---

Notes:

# Leaf Logic™

## Gutter Protection Systems

---

### Product Code/Description

---

LL510  
**5" Rippled Plate**

Nominal .015 Thick  
Length: 10'  
30 Pcs./Ctn.  
300'/Ctn.  
30 Lbs./Ctn.

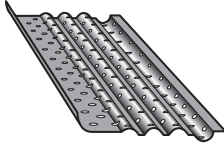

---

### Color Availability

---

00 Brushed Nickel  
JS Dark Bronze  
04 White

---

LL610  
**6" Rippled Plate**

Nominal .015 Thick  
Length: 10'  
30 Pcs./Ctn.  
300'/Ctn.  
35 Lbs./Ctn.

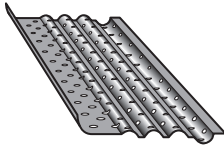

---

00 Brushed Nickel  
JS Dark Bronze  
04 White

# Leaf Smart™

## Gutter Protection Systems

---

### Product Code/Description

---

LS54  
**5" Steel Mesh**

Nominal .032 Thick  
Length: 4'  
25 Pcs./Ctn.  
100'/Ctn.  
26 Lbs./Ctn.

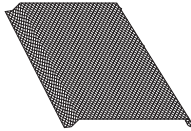

---

### Color Availability

---

Black

---

LS64  
**6" Steel Mesh**

Nominal .032 Thick  
Length: 4'  
25 Pcs./Ctn.  
100'/Ctn.  
28 Lbs./Ctn.

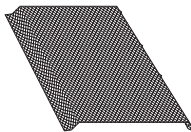

---

Black

# Roofing Accessories

## T-Drip

Product Code	Description	Face Length	Top Length	Part Length	Material	Finish	Nominal Thickness / Gauge	Pcs/ Ctn	Lbs/ Ctn	Color Group
TD1029L	T-Drip 1x2-7/8 Light	1"	2-7/8"	10'	Aluminum	Alumalure 2000	0.013	25	15.8	1
TD1029	T-Drip 1x2-7/8	1"	2-7/8"	10'	Aluminum	Alumalure 2000	0.016	25	19.2	4
TD1029H	T-Drip 1x2-7/8 Heavy	1"	2-7/8"	10'	Aluminum	Alumalure 2000	0.019	25	22.5	1
TD1029S	T-Drip 1x2-7/8 Galvanized	1"	2-7/8"	10'	Galvanized Steel	Polyester	0.016	25	51.1	2
TD1529	T-Drip 1-1/2x2-7/8	1-1/2"	2-7/8"	10'	Aluminum	Alumalure 2000	0.016	25	21.6	1
TD1529H	T-Drip 1-1/2x2-7/8 Heavy	1-1/2"	2-7/8"	10'	Aluminum	Alumalure 2000	0.019	25	25.2	5
TD1529H12	T-Drip 1-1/2x2-7/8x12' Heavy	1-1/2"	2-7/8"	12'	Aluminum	Alumalure 2000	0.019	25	30.3	5
TD1529S	T-Drip 1x2-7/8 Galvanized	1-1/2"	2-7/8"	10'	Galvanized Steel	Polyester	0.016	25	57.4	3
TD1549H	T-Drip 1-1/2x4-7/8 Heavy	1-1/2"	4-7/8"	10'	Aluminum	Alumalure 2000	0.019	25	35.5	1
TD1829	T-Drip 1-3/4x2-7/8	1-3/4"	2-7/8"	10'	Aluminum	Alumalure 2000	0.016	25	22.5	4
TD1829H	T-Drip 1-3/4x2-7/8 Heavy	1-3/4"	2-7/8"	10'	Aluminum	Alumalure 2000	0.019	25	26.4	5
TD1829S	T-Drip 1-3/4x2-7/8 Galvanized	1-3/4"	2-7/8"	10'	Galvanized Steel	Polyester	0.016	25	59.9	3
TD2029H	T-Drip 2x2-7/8 Heavy	2"	2-7/8"	10'	Aluminum	Alumalure 2000	0.019	25	28.3	1

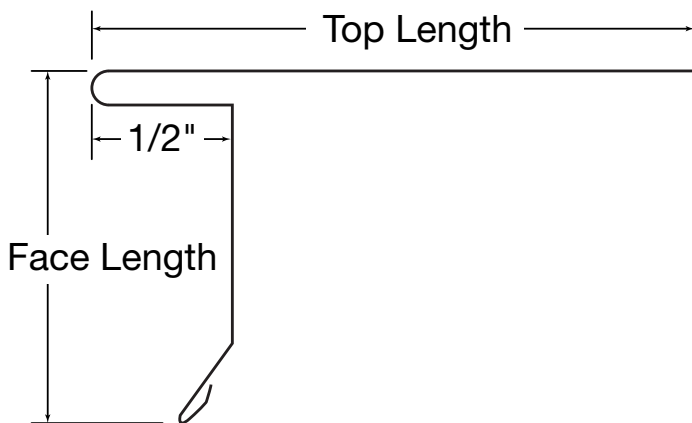

Color Group 1	White, Black, Dark Bronze, Musket Brown, Pebblestone Clay, Royal Brown, Terra Bronze
Color Group 2	Mill, White, Black, Dark Bronze, Musket Brown, Pebblestone Clay, Royal Brown, Terra Bronze
Color Group 3	Mill, White, Almond, Black, Cameo, Charcoal Grey, Dark Bronze, Desert Sand, Jefferson Tan, Montana Suede, Pebblestone Clay, Royal Brown, Sandtone, Terra Bronze, Wicker
Color Group 4	White, Almond, Black, Cameo, Dark Bronze, Musket Brown, Pebblestone Clay, Royal Brown, Terra Bronze, Wicker
Color Group 5	White, Almond, Black, Cameo, Charcoal Grey, Cream, Dark Bronze, Desert Sand, Evergreen, Jefferson Tan, Linen, London Brown, Montana Suede, Musket Brown, Pebblestone Clay, Royal Brown, Rugged Canyon, Russet Red, Sandtone, Silver Grey, Terra Bronze, Victorian Grey, Wicker

# Roofing Accessories

## F-Drip

Product Code	Description	Face Length	Top Length	Part Length	Material	Finish	Nominal Thickness / Gauge	Pcs/Ctn	Lbs/Ctn	Color Group
FD1060H	F-Drip 1x6 Heavy	1"	6"	10'	Aluminum	Alumalure 2000	0.019	25	35.5	1
FD1060S	F-Drip 1x6 Galvanized	1"	6"	10'	Galvanized Steel	Polyester	0.016	25	80.6	2
FD202012	F-Drip 2x2	2"	2"	12'	Aluminum	Alumalure 2000	0.016	25	23	1
FD2020H12	F-Drip 2x2x12' Heavy	2"	2"	12'	Aluminum	Alumalure 2000	0.019	25	27	1
FD202012S	F-Drip 2x2 Galvanized	2"	2"	12'	Galvanized Steel	Polyester	0.016	25	61.4	2
FD2028	F-Drip 2x2-3/4	2"	2-3/4"	10'	Aluminum	Alumalure 2000	0.016	25	22.5	1
FD2028H	F-Drip 2x2-3/4 Heavy	2"	2-3/4"	10'	Aluminum	Alumalure 2000	0.019	25	26.5	5
FD2028S	F-Drip 2x2-3/4 Galvanized	2"	2-3/4"	10'	Galvanized Steel	Polyester	0.016	25	59.9	3

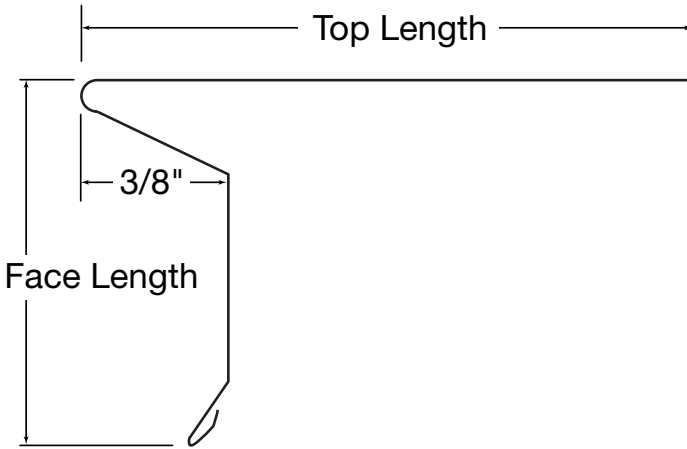

Color Group 1	White, Black, Dark Bronze, Musket Brown, Pebblestone Clay, Royal Brown, Terra Bronze
Color Group 2	Mill, White, Black, Dark Bronze, Musket Brown, Pebblestone Clay, Royal Brown, Terra Bronze
Color Group 3	Mill, White, Almond, Black, Cameo, Charcoal Grey, Desert Sand, Jefferson Tan, Montana Suede, Pebblestone Clay, Royal Brown, Sandtone, Terra Bronze, Wicker
Color Group 4	White, Almond, Black, Cameo, Dark Bronze, Musket Brown, Pebblestone Clay, Royal Brown, Terra Bronze, Wicker
Color Group 5	White, Almond, Black, Cameo, Charcoal Grey, Cream, Dark Bronze, Desert Sand, Evergreen, Jefferson Tan, Linen, London Brown, Montana Suede, Musket Brown, Pebblestone Clay, Royal Brown, Rugged Canyon, Russet Red, Sandtone, Silver Grey, Terra Bronze, Victorian Grey, Wicker

# Roofing Accessories

## C-Drip

Product Code	Description	Face Length	Top Length	Bottom Length	Part Length	Material	Finish	Nominal Thickness / Gauge	Pcs/ Ctn	Lbs/ Ctn	Color Group
CD1028H	C-Drip 1x2-3/4 Heavy	1"	2-3/4"	1-1/8"	10'	Aluminum	Alumalure 2000	0.019	25	26.4	5
CD1028S	C-Drip 1x2-3/4 Galvanized	1"	2-3/4"	1-1/8"	10'	Galvanized Steel	Polyester	0.016	25	59.9	3
CD1528H	C-Drip 1-1/2x2-3/4 Heavy	1-1/2"	2-3/4"	1-1/8"	10'	Aluminum	Alumalure 2000	0.019	25	28.3	1
CD1528S	C-Drip 1-1/2x2-3/4 Galvanized	1-1/2"	2-3/4"	1-1/8"	10'	Galvanized Steel	Polyester	0.016	25	64.3	2
CD2028H	C-Drip 2x2-3/4 Heavy	2"	2-3/4"	1-1/8"	10'	Aluminum	Alumalure 2000	0.019	25	31	1
CD2028S	C-Drip 2x2-3/4 Galvanized	2"	2-3/4"	1-1/8"	10'	Galvanized Steel	Polyester	0.016	25	70.4	2

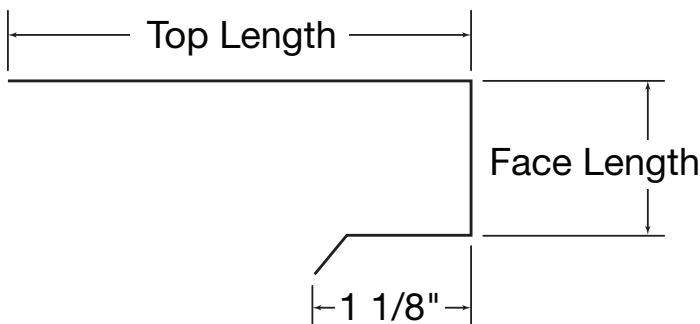

Color Group 1	White, Black, Dark Bronze, Musket Brown, Pebblestone Clay, Royal Brown, Terra Bronze
Color Group 2	Mill, White, Black, Dark Bronze, Musket Brown, Pebblestone Clay, Royal Brown, Terra Bronze
Color Group 3	Mill, White, Almond, Black, Cameo, Charcoal Grey, Desert Sand, Jefferson Tan, Montana Suede, Pebblestone Clay, Royal Brown, Sandtone, Terra Bronze, Wicker
Color Group 4	White, Almond, Black, Cameo, Dark Bronze, Musket Brown, Pebblestone Clay, Royal Brown, Terra Bronze, Wicker
Color Group 5	White, Almond, Black, Cameo, Charcoal Grey, Cream, Dark Bronze, Desert Sand, Evergreen, Jefferson Tan, Linen, London Brown, Montana Suede, Musket Brown, Pebblestone Clay, Royal Brown, Rugged Canyon, Russet Red, Sandtone, Silver Grey, Terra Bronze, Victorian Grey, Wicker

# Roofing Accessories

## Square Drip / Gutter Apron

Product Code	Description	Face Length	Top Length	Part Length	Material	Finish	Nominal Thickness / Gauge	Pcs/Ctn	Lbs/Ctn	Color Group
SD1515H	Sq Drip 1-1/2x1-1/2 Heavy	1-1/2"	1-1/2"	10'	Aluminum	Alumalure 2000	0.019	25	20.5	1
SD2025H	Sq Drip 2x2-1/2 Heavy	2"	2-1/2"	10'	Aluminum	Alumalure 2000	0.016	25	25.2	1
SD2025S	Sq Drip 2x2-1/2 Galvanized	2"	2-1/2"	10'	Galvanized Steel	Polyester	0.016	25	57.4	2

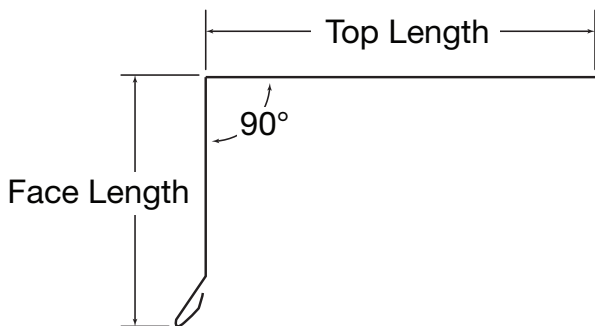

Product Code	Description	Face Length	Top Length	Part Length	Material	Finish	Nominal Thickness / Gauge	Pcs/Ctn	Lbs/Ctn	Color Group
GA2029H	Apron 2x2-7/8" Heavy	2"	2-7/8"	10'	Aluminum	Alumalure 2000	0.019	25	25.2	5
GA2029S	Apron 2x2-7/8" Galvanized	2"	2-7/8"	10'	Galvanized Steel	Polyester	0.016	25	57.4	3

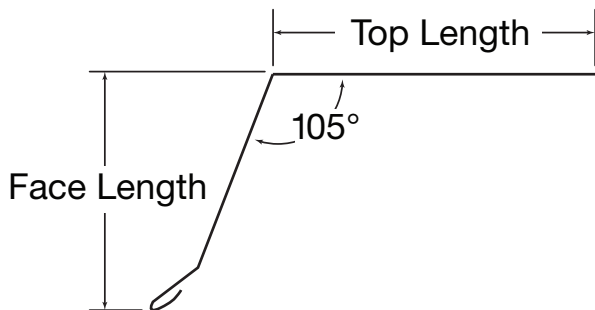

Color Group 1	White, Black, Dark Bronze, Musket Brown, Pebblestone Clay, Royal Brown, Terra Bronze
Color Group 2	Mill, White, Black, Dark Bronze, Musket Brown, Pebblestone Clay, Royal Brown, Terra Bronze
Color Group 3	Mill, White, Almond, Black, Cameo, Charcoal Grey, Desert Sand, Jefferson Tan, Montana Suede, Pebblestone Clay, Royal Brown, Sandtone, Terra Bronze, Wicker
Color Group 4	White, Almond, Black, Cameo, Dark Bronze, Musket Brown, Pebblestone Clay, Royal Brown, Terra Bronze, Wicker
Color Group 5	White, Almond, Black, Cameo, Charcoal Grey, Cream, Dark Bronze, Desert Sand, Evergreen, Jefferson Tan, Linen, London Brown, Montana Suede, Musket Brown, Pebblestone Clay, Royal Brown, Rugged Canyon, Russet Red, Sandtone, Silver Grey, Terra Bronze, Victorian Grey, Wicker

# Roofing Accessories

## Quick Drip / Gravel Stop

Product Code	Description	Face Length	Top Length	Part Length	Material	Finish	Nominal Thickness / Gauge	Pcs/ Ctn	Lbs/ Ctn	Color Group
QD2410H12	Quick Drip 2-7/16x12 Heavy	2-7/16"	1"	12'	Aluminum	Alumalure 2000	0.019	25	20.5	5

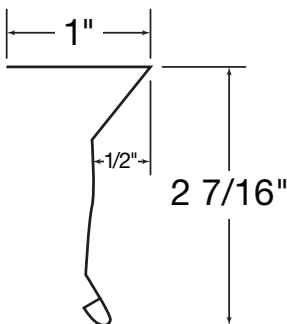

Product Code	Description	Face Length	Top Length	Part Length	Material	Finish	Nominal Thickness / Gauge	Pcs/ Ctn	Lbs/ Ctn	Color Group
GS4040XH	Gravel Stop 4x4 Extra Heavy	4"	4"	10'	Aluminum	Alumalure 2000	0.024	25	25.2	1

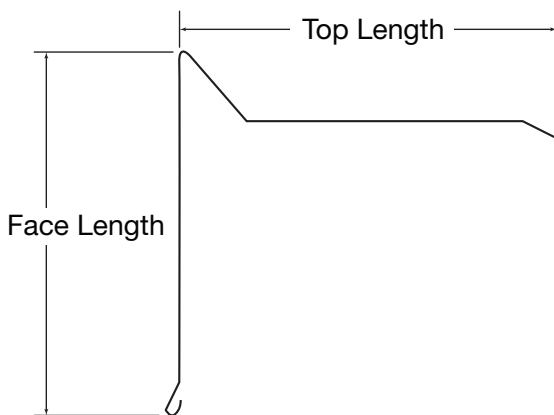

Color Group 1	White, Black, Dark Bronze, Musket Brown, Pebblestone Clay, Royal Brown, Terra Bronze
Color Group 2	Mill, White, Black, Dark Bronze, Musket Brown, Pebblestone Clay, Royal Brown, Terra Bronze
Color Group 3	Mill, White, Almond, Black, Cameo, Charcoal Grey, Desert Sand, Jefferson Tan, Montana Suede, Pebblestone Clay, Royal Brown, Sandtone, Terra Bronze, Wicker
Color Group 4	White, Almond, Black, Cameo, Dark Bronze, Musket Brown, Pebblestone Clay, Royal Brown, Terra Bronze, Wicker
Color Group 5	White, Almond, Black, Cameo, Charcoal Grey, Cream, Dark Bronze, Desert Sand, Evergreen, Jefferson Tan, Linen, London Brown, Montana Suede, Musket Brown, Pebblestone Clay, Royal Brown, Rugged Canyon, Russet Red, Sandtone, Silver Grey, Terra Bronze, Victorian Grey, Wicker

# Roofing Accessories

## Flat Flashing Squares

Product Code	Description	A Length	B Length	C Length	Material	Finish	Nominal Thickness / Gauge	Pcs/Ctn	Lbs/Ctn	Color Group
FF57	Flat Square 5x7	5"	7"	n/a	Aluminum	Alumalure 2000	0.013	500	21.1	0
FF57S	Flat Square 5x7 Galvanized	5"	7"	n/a	Galvanized Steel	Polyester	0.016	100	13.6	0
FF68	Flat Square 6x8	6"	8"	n/a	Aluminum	Alumalure 2000	0.013	500	29	0
FF68S	Flat Square 6x8 Galvanized	6"	8"	n/a	Galvanized Steel	Polyester	0.016	100	18.6	0
FF77	Flat Square 7x7	7"	7"	n/a	Aluminum	Alumalure 2000	0.013	500	29.5	0
FF77S	Flat Square 7x7 Galvanized	7"	7"	n/a	Galvanized Steel	Polyester	0.016	100	19	0
FF88	Flat Square 8x8	8"	8"	n/a	Aluminum	Alumalure 2000	0.013	500	38.6	0
FF88S	Flat Square 8x8 Galvanized	8"	8"	n/a	Galvanized Steel	Polyester	0.016	100	24.8	0

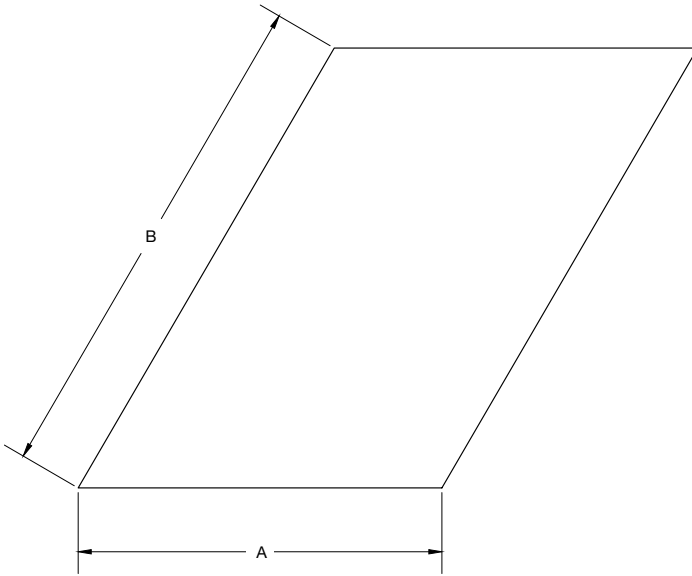

Color Group 0 | Mill, White/Black, Royal Brown/Terra Bronze

Color Group 1 | Mill, White, Black, Royal Brown, Terra Bronze

# Roofing Accessories

## Prebent Flashing Squares

Product Code	Description	A Length	B Length	C Length	Material	Finish	Nominal Thickness / Gauge	Pcs/ Ctn	Lbs/ Ctn	Color Group
PBF237	Prebent Square 2x3x7	2"	3"	7"	Aluminum	Alumalure 2000	0.013	500	21.1	1
PBF237S	Prebent Square 2x3x7 Galvanized	2"	3"	7"	Galvanized Steel	Polyester	0.016	100	13.6	1
PBF338	Prebent Square 3x3x8	3"	3"	8"	Aluminum	Alumalure 2000	0.013	500	29	1
PBF338S	Prebent Square 3x3x8 Galvanized	3"	3"	8"	Galvanized Steel	Polyester	0.016	100	18.6	1
PBF347	Prebent Square 3x4x7	3"	4"	7"	Aluminum	Alumalure 2000	0.013	500	29.5	1
PBF347S	Prebent Square 3x4x7 Galvanized	3"	4"	7"	Galvanized Steel	Polyester	0.016	100	19	1
PBF448	Prebent Square 4x4x8	4"	4"	8"	Aluminum	Alumalure 2000	0.013	500	38.6	1
PBF448S	Prebent Square 4x4x8 Galvanized	4"	4"	8"	Galvanized Steel	Polyester	0.016	100	24.8	1

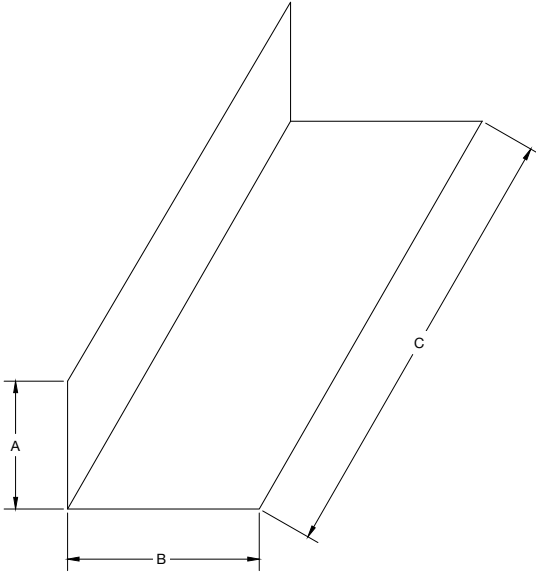

Color Group 0 Mill, White/Black, Royal Brown/Terra Bronze

Color Group 1 Mill, White, Black, Royal Brown, Terra Bronze

# Roofing Accessories

## W-Valley

Product Code	Description	Width	Length	Material	Finish	Nominal Thickness / Gauge	Pcs/ Ctn	Lbs/ Ctn	Color Group
WW18H	18" W-Valley Hemmed	18"	10'	Aluminum	Alumalure 2000	0.019	150	525	1
WW18S	18" W-Valley Galv Unhemmed	18"	10'	Galvanized Steel	Polyester	0.016	150	1260	1
WW18HS	18" W-Valley Hemmed Galv	18"	10'	Galvanized Steel	Polyester	0.016	150	1260	1
WW18HRS	18" W-Valley Hemmed Ribbed Galv	18"	10'	Galvanized Steel	Polyester	0.016	150	1260	1
WW20H	20" W-Valley Hemmed	20"	10'	Aluminum	Alumalure 2000	0.019	150	585	1
WW20S	20" W-Valley Galv Unhemmed	20"	10'	Galvanized Steel	Polyester	0.016	150	1400	1
WW20HS	20" W-Valley Hemmed Galv	20"	10'	Galvanized Steel	Polyester	0.016	150	1400	1
WW20HRS	20" W-Valley Hemmed Ribbed Galv	20"	10'	Galvanized Steel	Polyester	0.016	150	1400	1
WW24H	24" W-Valley Hemmed	24"	10'	Aluminum	Alumalure 2000	0.019	150	705	1
WW24S	24" W-Valley Galv Unhemmed	24"	10'	Galvanized Steel	Polyester	0.016	150	1680	1
WW24HS	24" W-Valley Hemmed Galv	24"	10'	Galvanized Steel	Polyester	0.016	150	1680	1
WW24HRS	24" W-Valley Hemmed Ribbed Galv	24"	10'	Galvanized Steel	Polyester	0.016	150	1680	1

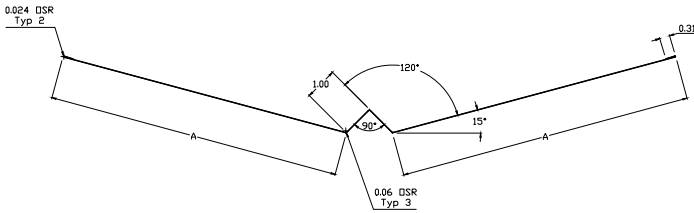

Color Group 0 | Mill, White/Black, Royal Brown/Terra Bronze

Color Group 1 | Mill, White, Black, Royal Brown, Terra Bronze

# Roofing Accessories

## Roll Valley

Product Code	Description	Width	Length	Material	Finish	Nominal Thickness / Gauge	Pcs/ Ctn	Lbs/ Ctn	Color Group
RF2450	24"x50' Roll Flashing .013	24"	50'	Aluminum	Alumalure 2000	0.013	1	17	0
RF2450S	24"x50' Roll Flashing Galv	24"	50'	Galvanized Steel	Polyester	0.016	1	56	0
RF2425	24"x25' Roll Flashing .013	24"	25'	Aluminum	Alumalure 2000	0.013	1	9	0
RF2425S	24"x25' Roll Flashing Galv	24"	25'	Galvanized Steel	Polyester	0.016	1	28	0
RF2050	20"x50' Roll Flashing .013	20"	50'	Aluminum	Alumalure 2000	0.013	1	14	0
RF2050S	20"x50' Roll Flashing Galv	20"	50'	Galvanized Steel	Polyester	0.016	1	46	0
RF2025	20"x25' Roll Flashing .013	20"	25'	Aluminum	Alumalure 2000	0.013	1	7	0
RF2025S	20"x25' Roll Flashing Galv	20"	25'	Galvanized Steel	Polyester	0.016	1	23	0
RF1650	16"x50' Roll Flashing .013	16"	50'	Aluminum	Alumalure 2000	0.013	1	12	0
RF1650S	16"x50' Roll Flashing Galv	16"	50'	Galvanized Steel	Polyester	0.016	1	37	0
RF1625	16"x25' Roll Flashing .013	16"	25'	Aluminum	Alumalure 2000	0.013	1	6	0
RF1625S	16"x25' Roll Flashing Galv	16"	25'	Galvanized Steel	Polyester	0.016	1	19	0
RF1450	14"x50' Roll Flashing .013	14"	50'	Aluminum	Alumalure 2000	0.013	1	10	0
RF1450S	14"x50' Roll Flashing Galv	14"	50'	Galvanized Steel	Polyester	0.016	1	33	0
RF1425	14"x25' Roll Flashing .013	14"	25'	Aluminum	Alumalure 2000	0.013	1	5	0
RF1425S	14"x25' Roll Flashing Galv	14"	25'	Galvanized Steel	Polyester	0.016	1	16	0
RF1250	12"x50' Roll Flashing .013	12"	50'	Aluminum	Alumalure 2000	0.013	1	9	0
RF1250S	12"x50' Roll Flashing Galv	12"	50'	Galvanized Steel	Polyester	0.016	1	28	0
RF1225	12"x25' Roll Flashing .013	12"	25'	Aluminum	Alumalure 2000	0.013	1	4	0
RF1225S	12"x25' Roll Flashing Galv	12"	25'	Galvanized Steel	Polyester	0.016	1	14	0
RF1050	10"x50' Roll Flashing .013	10"	50'	Aluminum	Alumalure 2000	0.013	1	7	0
RF1050S	10"x50' Roll Flashing Galv	10"	50'	Galvanized Steel	Polyester	0.016	1	23	0
RF1025	10"x25' Roll Flashing .013	10"	25'	Aluminum	Alumalure 2000	0.013	1	4	0
RF1025S	10"x25' Roll Flashing Galv	10"	25'	Galvanized Steel	Polyester	0.016	1	12	0
RF850	8"x50' Roll Flashing .013	8"	50'	Aluminum	Alumalure 2000	0.013	1	6	0
RF850S	8"x50' Roll Flashing Galv	8"	50'	Galvanized Steel	Polyester	0.016	1	19	0
RF825	8"x25' Roll Flashing .013	8"	25'	Aluminum	Alumalure 2000	0.013	1	3	0
RF825S	8"x25' Roll Flashing Galv	8"	25'	Galvanized Steel	Polyester	0.016	1	9	0
RF650	6"x50' Roll Flashing .013	6"	50'	Aluminum	Alumalure 2000	0.013	1	4	0
RF650S	6"x50' Roll Flashing Galv	6"	50'	Galvanized Steel	Polyester	0.016	1	14	0
RF625	6"x25' Roll Flashing .013	6"	25'	Aluminum	Alumalure 2000	0.013	1	2	0
RF625S	6"x25' Roll Flashing Galv	6"	25'	Galvanized Steel	Polyester	0.016	1	7	0
RF450	4"x50' Roll Flashing .013	4"	50'	Aluminum	Alumalure 2000	0.013	1	3	0
RF450S	4"x50' Roll Flashing Galv	4"	50'	Galvanized Steel	Polyester	0.016	1	9	0
RF425	4"x25' Roll Flashing .013	4"	25'	Aluminum	Alumalure 2000	0.013	1	1	0
RF425S	4"x25' Roll Flashing Galv	4"	25'	Galvanized Steel	Polyester	0.016	1	5	0

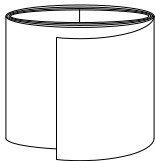

Color Group 0 | Mill, White/Black, Royal Brown/Terra Bronze  
 Color Group 1 | Mill, White, Black, Royal Brown, Terra Bronze

# Ply Gem Steel Siding and Accessories

## Product Code/Description

## Color Availability

8SWG

### 8" Woodgrain

Coating: Textured, SMP  
 Material: 28g G60 Steel  
 Length: 12' 6"  
 12 Pcs./Ctn.  
 1 Sq./Ctn.  
 85 Lbs./Ctn.

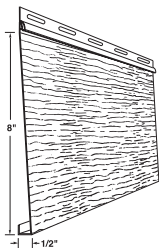

White  
 Almond  
 Brandy Wood  
 Cameo  
 Charcoal Grey  
 Dark Bronze  
 Deep Granite  
 Desert Sand  
 Jefferson Tan  
 Mahogany  
 Montana Suede  
 Musket Brown  
 Natural Slate  
 Newport Bay  
 Pebblestone Clay  
 Quiet Willow  
 Red Brick  
 Rugged Canyon  
 Terra Bronze  
 Wicker

D4SWG

### Double 4" Woodgrain

Coating: Textured, SMP  
 Material: 28g G60 Steel  
 Length: 12' 6"  
 12 Pcs./Ctn.  
 1 Sq./Ctn.  
 91 Lbs./Ctn.

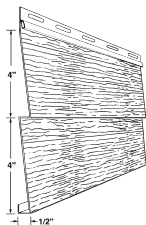

D5SWG

### Double 5" Woodgrain

Coating: Textured, SMP  
 Material: 28g G60 Steel  
 Length: 12'  
 10 Pcs./Ctn.  
 1 Sq./Ctn.  
 87 Lbs./Ctn.

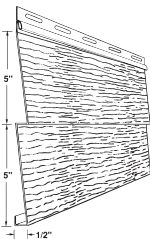

Notes:

# Ply Gem Steel Siding and Accessories

---

## Product Code/Description

---

D5DLSWG  
**Double 5" Dutch Lap  
Woodgrain**

Coating: Textured, SMP  
Material: 28g G60 Steel  
Length: 12'  
10 Pcs./Ctn.  
1 Sqs./Ctn.  
87 Lbs./Ctn.

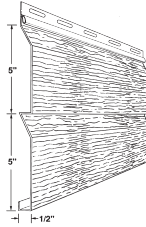

---

## Color Availability

---

White  
Almond  
Brandy Wood  
Cameo  
Charcoal Grey  
Dark Bronze  
Deep Granite  
Desert Sand  
Jefferson Tan  
Mahogany  
Montana Suede  
Musket Brown  
Natural Slate  
Newport Bay  
Pebblestone Clay  
Quiet Willow  
Red Brick  
Rugged Canyon  
Terra Bronze  
Wicker

---

BB10SWG  
**Board & Batten  
10" Woodgrain**

Coating: Textured, SMP  
Material: 28g G60 Steel  
Length: 10'  
12 Pcs./Ctn.  
1 Sqs./Ctn.  
87 Lbs./Ctn.

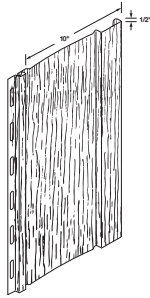

---

Notes:

# Ply Gem Steel Siding and Accessories

## Product Code/Description

## Color Availability

S1WAP

### Starter Strip

Coating: Mill  
Material: 28g G60 Steel  
Length: 10'  
40 Pcs./Ctn.  
55 Lbs./Ctn.

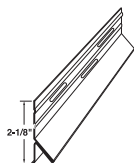

Mill Finish

OCPSWG

### 1 Piece Woodgrain Outside Corner Post

Coating: Textured, SMP  
Material: 28g G60 Steel  
Length: 10'  
10 Pcs./Ctn.  
67 Lbs./Ctn.

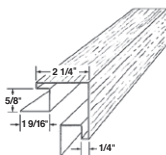

White  
Almond  
Brandy Wood  
Cameo  
Charcoal Grey  
Dark Bronze  
Deep Granite  
Desert Sand  
Jefferson Tan  
Mahogany  
Montana Suede  
Musket Brown  
Natural Slate  
Newport Bay  
Pebblestone Clay  
Quiet Willow  
Red Brick  
Rugged Canyon  
Terra Bronze  
Wicker

OCPSSM

### 1 Piece Smooth Outside Corner Post

Coating: Textured, SMP  
Material: 28g G60 Steel  
Length: 10'  
10 Pcs./Ctn.  
67 Lbs./Ctn.

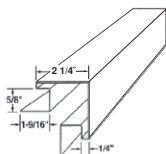

CAPSWG

### 2 Piece Woodgrain Outside Corner Post Cap

Coating: Textured, SMP  
Material: 28g G60 Steel  
Length: 12'  
10 Pcs./Ctn.  
53 Lbs./Ctn.

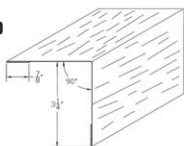

No Color

BASE2P0625 00

### 2 Piece Outside Corner Post 5/8" Base

Coating: Textured, SMP  
Material: 28g G60 Steel  
Length: 12'  
10 Pcs./Ctn.  
48 Lbs./Ctn.

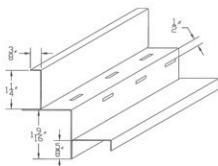

# Ply Gem Steel Siding and Accessories

Product Code/Description

Color Availability

BASE2P1125 00  
**2 Piece Outside Corner  
Post 1-1/8" Base**

Coating: Textured,  
SMP

Material: 28g G60 Steel

Length: 12'

10 Pcs./Ctn.

55 Lbs./Ctn.

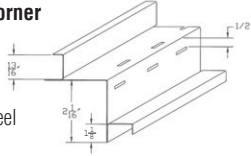

No Color

78SJ

**7/8" J Channel**

Coating: Textured, SMP

Finish: 28g G60 Steel

Nominal .019 Thick

Length: 12'

25 Pcs./Ctn.

52 Lbs./Ctn.

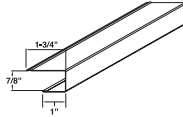

White  
Almond  
Brandy Wood  
Cameo  
Charcoal Grey  
Dark Bronze  
Deep Granite  
Desert Sand  
Jefferson Tan  
Mahogany  
Montana Suede  
Musket Brown  
Natural Slate  
Newport Bay  
Pebblestone Clay  
Quiet Willow  
Red Brick  
Rugged Canyon  
Terra Bronze  
Wicker

UTS

**General Purpose Trim**

Coating: Textured, SMP

Material: 28g G60 Steel

Length: 12' 6"

20 Pcs./Ctn.

36 Lbs./Ctn.

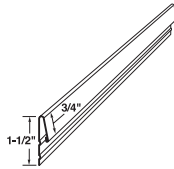

Notes:

# Ply Gem Steel Siding and Accessories

---

## Product Code/Description

34JS

### 3/4" J Channel

Coating: Textured, SMP

Finish: 28g G60 Steel

Length: 10'

25 Pcs./Ctn.

45 Lbs./Ctn.

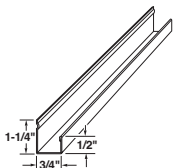

---

## Color Availability

White  
Almond  
Brandy Wood  
Cameo  
Charcoal Grey  
Dark Bronze  
Deep Granite  
Desert Sand  
Jefferson Tan  
Mahogany  
Montana Suede  
Musket Brown  
Natural Slate  
Newport Bay  
Pebblestone Clay  
Quiet Willow  
Red Brick  
Rugged Canyon  
Terra Bronze  
Wicker

---

125JS

### 1 1/4" J Channel

Coating: Textured, SMP

Finish: 28g G60 Steel

Length: 12'

25 Pcs./Ctn.

65 1/2 Lbs./Ctn.

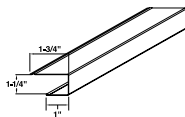

*(Extended Lead Time. Available as special order/1 Ctn Min.)*

---

SSTU

### Touch-Up Pen

Felt tip

1/3 oz. pen

1/Ctn.

.051 Lbs./Ctn.

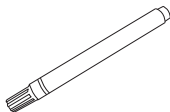

---

Notes:

# Ply Gem Steel Siding and Accessories - Coil

---

## Product Code/Description

---

STC2175

### Trim Coil

Coating: Textured, SMP  
Material: 28g G60 Steel  
Length: 50' x 21.75"  
60 Lbs./Ctn.

---

SC10625

### 10-5/8" Seamless Siding Coil

Coating: Textured, SMP  
Material: 28g G60 Steel  
Width: 10.625"  
Weight: 700lbs +/-70lbs

---

SC13250

### 13-1/4" Seamless Siding Coil

Coating: Textured, SMP  
Material: 28g G60 Steel  
Width: 13.25"  
Weight: 700lbs +/-70lbs

---

SRSC10625

### 10-5/8" Seamless Siding Coil

Coating: Textured, SMP  
Material: 28g G60 Steel  
Width: 10.625"  
Weight: 350lbs

---

SRSC13250

### 13-1/4" Seamless Siding Coil

Coating: Textured, SMP  
Material: 28g G60 Steel  
Width: 13.25"  
Weight: 350lbs

---

## Color Availability

---

White	Musket Brown
Almond	Natural Slate
Brandy Wood	Newport Bay
Cameo	Pebblestone Clay
Charcoal Grey	Quiet Willow
Classic Cream	Red Brick
Dark Bronze	Royal Brown
Deep Granite	Rugged Canyon
Desert Sand	Sandtone
Jefferson Tan	Stone Clay
Mahogany	Terra Bronze
Montana Suede	Wicker

---

White
Almond
Brandy Wood
Cameo
Charcoal Grey
Dark Bronze
Deep Granite
Desert Sand
Jefferson Tan
Mahogany
Montana Suede
Musket Brown
Natural Slate
Newport Bay
Pebblestone Clay
Quiet Willow
Red Brick
Rugged Canyon
Terra Bronze
Wicker

# Ply Gem Steel Siding and Accessories - Fascia

## Product Code/Description

## Color Availability

F4SWG

### Wood Grain Embossed 4" Fascia Trim

Coating: Textured, SMP  
Material: 28g G60 Steel  
Length: 10'  
20 Pcs./Ctn.  
55 Lbs./Ctn.

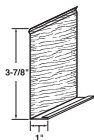

White  
Dark Bronze  
Musket Brown  
Pebblestone Clay  
Wicker

F6SWG

### Wood Grain Embossed 6" Fascia Trim

Coating: Textured, SMP  
Material: 28g G60 Steel  
Length: 10'  
18 Pcs./Ctn.  
69 Lbs./Ctn.

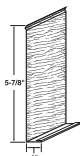

White  
Almond  
Cameo  
Charcoal Grey  
Classic Cream  
Dark Bronze  
Desert Sand  
Jefferson Tan  
Montana Suede  
Musket Brown  
Pebblestone Clay  
Quiet Willow  
Royal Brown  
Rugged Canyon  
Sandtone  
Stone Clay  
Terra Bronze  
Wicker

F8SWG

### Wood Grain Embossed 8" Fascia Trim

Coating: Textured, SMP  
Material: 28g G60 Steel  
Length: 10'  
16 Pcs./Ctn.  
78 Lbs./Ctn.

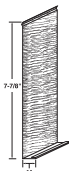

White  
Dark Bronze  
Musket Brown  
Pebblestone Clay  
Wicker

F10SWG

### Envoy Wood Grain Embossed 10" Fascia Trim

Coating: Textured, SMP  
Material: 28g G60 Steel  
Length: 10'  
12 Pcs./Ctn.  
71 Lbs./Ctn.

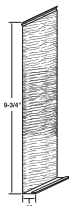

# Specifications and Conformance

## TECHNICAL SPECIFICATIONS

Mastic Product line	Design Pressure (DP)	Wind Velocity (mph)
CD Hand-Spilt Shake	82.2 PSF	180
CD Shingle D7"	73.3 PSF	175
CD Shingle T5"	73.3 PSF	175
CD Half-Round	48.9 PSF	145
Structure	68.9 PSF	170
Quest	89.4 PSF	190
Carvedwood 44	77.2 PSF	178
T-Lok Barkwood	55.6 PSF	150
Liberty Elite	55.6 PSF	150
Western Extreme	77.2 PSF	178
Charleston Beaded	80.2 PSF	180
Board & Batten	92.6 PSF	193
Ovation	77.2 PSF	178
Mill Creek	55.6 PSF	150
Eclipse	55.6 PSF	150
Envoy Alum.	64.0 PSF	165
Endurance Alum.	64.0 PSF	165

## VINYL SIDING + SOFFIT

*Mastic siding and soffit products are designed for use in residential and light commercial applications.*

### FINISH

Mastic vinyl siding and soffit are produced from a PVC compound containing quality color pigments to provide color throughout the thickness of the panel. Close control of color and gloss is maintained to provide for an attractive, weatherable surface. Textured vinyl panels are uniformly embossed to provide an attractive woodgrain pattern.

For cedar-look colors, Kynar 500® has been formulated into a film, which becomes an integral part of an exclusive layering process. The film finish system exhibits no cracking, blistering, corrosion or loss of adhesion when subjected to extreme test cycles of cold, heat, acid rain and humidity. Test results are available upon request.

\*Kynar 500® is a registered trademark of Elf Atochem North America, Inc.

### MANUFACTURING PHYSICALS

Solid vinyl siding, soffit and accessories are an extruded polyvinyl chloride (PVC) compound as defined in ASTM D3679, Standard Specification for PVC Siding.™ The cell classification as defined by ASTM D1784 is 13344-B.

Mastic PVC resin meets or exceeds the properties listed here:

Tensile strength (psi)	7,100 – 7,600
Tensile modulus (psi)	360,000 – 400,000
Specific gravity	1.39 – 1.49
Hardness (ShoreD)	76 ± 3
Heat deflection under load 264 psi	170°F
Izod impact strength (ft-lbs/in of notch)	3.3
Chemical resistance	Excellent
Coefficient of linear expansion	2.9 (73.7) X 10-5

## THICKNESS

Mastic vinyl siding and soffit panels exceed requirements per ASTM D3679 section 4.2.

### Siding thickness (nominal)

Board+Batten Designer Series™	.048" (1.22)	Ovation™	.042" (1.07)
Passage™	.050" (1.27)	Mill Creek®	.040" (1.02)
Structure® (Vinyl)	.046" (1.17)	Eclipse™	.040" (1.02)
Liberty Elite®	.048" (1.22)	T-Lok Barkwood®	.048" (1.22)
Charleston Beaded™	6-1/2"	Quest®	.046" (1.17)
(Contemporary)	.044" (1.12)	Carvedwood•44™	.044" (1.16)

### Soffit thickness (nominal)

Ventura®	.044" (1.12)	Pro-Tech® Plus Double 5"	.042" (1.07)
Pro-Bead®	.040" (1.02)	Universal D5	.040" (1.02)
Pro-Select®	.046" (1.17)	Universal T4	.036" (0.91)
Pro-Tech® Plus Triple 4"	.040" (1.02)		

NOTE: All measurements noted in ( ) are in centimeters (cm).

## VENTILATION AREA

(Free air space area in sq in/sq ft)

Ventura®	9.19 sq in (59.290 cm <sup>2</sup> )	Pro-Tech® Plus Double 5"	7.53 sq in (48.581 cm <sup>2</sup> )
Pro-Bead®	1.54 sq in (9.9355 cm <sup>2</sup> )	Pro-Tech® Plus Triple 4"	5.87 sq in (37.871 cm <sup>2</sup> )
Pro-Select®	7.53 sq in (48.581 cm <sup>2</sup> )	Universal D5	7.53 sq in (48.581 cm <sup>2</sup> )
Pro-Tech® Plus Triple 4"	5.87 sq in (37.871 cm <sup>2</sup> )	Universal T4	5.87 sq in (37.871 cm <sup>2</sup> )

## RELEVANT STANDARDS/CODES

Mastic vinyl siding products meet or exceed the following industry standards and/or building code approvals:

### Standards and Codes

Standards and Codes	Patent #
ASTM	C1363
ASTM	C272
ASTM	D2843 (U.B.C. #52-2)
ASTM	D635
ASTM	E84
ASTM	E96
ASTM	D3679
ASTM	D4477
ASTM	D7793
Metro Dade	08-0429.11
State of Florida	5538-R1
State of Florida	11191
State of Florida	5544
State of Florida	12141
Texas State Board of Insurance Ruling	EC-27
ICC Evaluation Service	NER-638

### Fire-Resistance Ratings

ASTM E84	ASTM D635		
Flame spread	less than 20	Avg. time of burning	less than 5 sec.
Fuel contribution	0	Avg. length of burning	20 mm
Smoke density	400		
ASTM E-119	ASTM D2843 (U.B.C. #52-2)		
1 hour firewall,	Smoke density		48
1 hour firewall,			
Standard test	UBC 26-9		
method for fire	Intermediate-scale		
Tests of building	Multistory fire test		
Construction and materials			

### Windload Ratings

Cedar Discovery® Hand-Split Shake	190 mph	Liberty Elite®	165 mph
Cedar Discovery® Perfection Shingle D7®	210 mph	Charleston Beaded™	165 mph
Cedar Discovery® Perfection Shingle T5®	230 mph	Board + Batten Designer Series™	175 mph
Cedar Discovery® Half-Round	180 mph	Mill Creek®	165 mph
Structure® Home Insulation System™	190 mph	Quest®	240 mph
Eclipse™	165 mph	Carvedwood 44™	200 mph
Envoy® Aluminum Siding	165 mph	Ovation™	195 mph
Endurance® Aluminum Siding	165 mph	T-Lok Barkwood®	165 mph

## IMPORTANT: FIRE SAFETY INFORMATION

Exterior vinyl building materials require little maintenance for many years. Nevertheless, common sense dictates that builders and suppliers of vinyl products store, handle and install vinyl materials in a manner that avoids damage to the product and/or structure. Owners and installers should take a few simple steps to protect vinyl building materials from fire.

### To Home and Building Owners

Rigid vinyl siding is made from organic materials and will melt or burn when exposed to a significant source of flame or heat. Building owners, occupants and outside maintenance personnel should always take normal precautions to keep sources of fire, such as barbecues, and combustible materials, dry leaves, mulch and trash away from vinyl siding.

### To Building Trades, Specifiers, Professionals and Do-It-Yourself Installers

When rigid vinyl siding is exposed to significant heat or flames, the vinyl will soften, sag, melt or burn, and may thereby expose material underneath. Care must be exercised when selecting underlayment materials because many underlayment materials are made from organic materials that are combustible. Fire properties of underlayment materials should be ascertained prior to installation. All building materials should be installed in accordance with local, state and federal building code and fire regulations.

WALL FIRE RESISTANCE MATRIX				
	Wall System	Interior Underlayment	Exterior Sheathing	Popular Residential Claddings*
<b>Non-rated Wall</b>	Any conventional construction	1/2" gypsum board	Any conventional materials	Wood Plywood OSB Hardboard Steel Aluminum Vinyl
<b>One-hour Rating</b>	Any conventional construction	1 layer of 5/8" gypsum board	MUST INCLUDE 1 layer of 5/8" gypsum board	
<b>Two-hour Rating</b>	Any conventional construction	2 layers of 5/8" gypsum board	MUST INCLUDE 2 layers of 5/8" gypsum board	

\*NOTE: Fire-treated versions may also be available for some popular wood-based siding products. For general information about vinyl siding products, contact the Vinyl Siding Institute, 1201 15th St. NW, Suite 220, Washington, DC 20005. Request brochures titled, "Fire Properties" and "What Homeowners Want to Know."

## WARRANTY

Mastic backs its vinyl siding and soffit with a Mastic V.I.P. Limited Lifetime Warranty. Many products also include hail coverage. Consult actual warranty certificates for complete coverage details.

## CEDAR DISCOVERY® SHINGLE SIDING

*Mastic Cedar Discovery® shingle siding is designed for use in residential and light commercial applications.*

## FINISH

Cedar Discovery® shingle siding is produced from a polypropylene compound containing quality color pigments to provide color throughout the thickness of the panel. Close control of color and gloss is maintained to provide for an attractive, weatherable surface.

## MANUFACTURING PHYSICALS

### Double 7" Perfection Shingle Siding

1. Style: Double 7" profile, 14" exposure
2. Butt dimension: 3/4"
3. Length: 67-1/2"
4. Nail hem: continuous locking nail hem
5. Thickness: nominal .080"
6. Material: polypropylene

### Half-Round

1. Style: Double Round 6-1/4" profile, 12-1/2" exposure
2. Butt dimension: 3/4"
3. Length: 51-3/4"
4. Nail hem: continuous locking nail hem
5. Thickness: nominal .080"
6. Material: polypropylene

### Triple 5" Perfection Shingle Siding

1. Style: Triple 5" profile, 15" exposure
2. Butt dimension: 3/4"
3. Length: 69-1/2"
4. Nail hem: continuous locking nail hem
5. Thickness: nominal .100"
6. Material: polypropylene

### Hand-Split Shake

1. Style: Double 9-3/8" profile, 18-3/4" exposure
2. Butt dimension: 7/8"
3. Length: 67-3/4"
4. Nail hem: continuous locking nail hem
5. Thickness: nominal .080"
6. Material: polypropylene

## RELEVANT STANDARDS/CODES

Cedar Discovery® shingle siding is a rigid polypropylene siding. Cedar Discovery® shingle siding, tested in compliance to ASTM flame test procedures, meets or exceeds the following properties as required by the national code bodies.

Burn rate	ASTM D635 – 1.15'/minute
Minimum self-ignition temperature	ASTM D1929 – 673F
Minimum flash-ignition temperature	ASTM D1929 – 651F
Flame spread and smoke developed	ASTM E84 – Flame 150, Smoke 710
Windload	ASTM D5206 – 80 psf, 180 mph

NOTE: Cedar Discovery® has been tested per ASTM D5206 standard test method for windload resistance of rigid PVC siding. Check with your local building inspector for windload requirements in your area.

## DELIVERY, STORAGE AND HANDLING

Deliver rigid polypropylene siding products to the project site in their original packaging. Store rigid polypropylene products in their original packaging on a flat surface under cover, stacked no more than 12 boxes high. Do not store in a location where temperatures may exceed 130F.

## IMPORTANT: FIRE SAFETY INFORMATION

Rigid polypropylene siding is made from organic materials and will melt or burn when exposed to a significant source of flame or heat. Property owners, occupants and maintenance personnel should be familiar with the performance characteristics of underlayment materials. For maximum safety, non-combustible underlayment materials are recommended. Normal precautions to protect rigid polypropylene building materials from sources of fire should be taken. Barbecues and combustible materials, such as dry leaves, mulch and trash, should be kept away from polypropylene siding.

## WARRANTY

Mastic Cedar Discovery® shingle siding has Mastic's V.I.P. Limited Lifetime Warranty. Consult the actual product warranty for complete coverage details.

## ALUMINUM SIDING, SOFFIT + TRIM SHEET

*Mastic siding and soffit products are designed for use in residential and light commercial applications.*

## FINISH

Siding and Soffit: The Alunalure® 2000 finish is a two-coat acrylic applied in a two-phase operation that includes a corrosion-inhibiting primer and a baked-on, high-performance acrylic topcoat.

Trim Sheet: Available in the Alunalure® 2000 smooth finish and the PVC coated striated finish. All Mastic aluminum siding and soffit panels exceed requirements per AAMA 1402.86.

## MANUFACTURING PHYSICALS

Mastic aluminum siding and soffit are made of 3105 aluminum sheet (minimum tensile strength 29,000 psi; minimum yield strength 26,000 psi).

## THICKNESS

Siding thickness (nominal)

Endurance® Rustic Double 4"	.019 (.483)	Envoy® Traditional Select 8"	.024 (.610)
Envoy® Rustic Double 4"	.024 (.610)	Envoy® Horizon Collection Double 5"	.024 (.610)
Endurance™ Double 5" Dutch Lap	.019 (.483)		

Soffit thickness (nominal)

Envoy®	.019 (.483)	Economy™	.013 (.331)
Endurance®	.016 (.406)		

Trim sheet thickness: Available in nominal .018, .019 and .024 thickness.

NOTE: All measurements noted in ( ) are in millimeters (mm).

## R-VALUE

Mastic aluminum siding, when installed over a flat wall, has an R-value of approximately 0.74. If applied over foil, the R-value increases to approximately 1.10.

## SOFFIT VENTILATION AREA

(free air space area in sq cm/ft)

Envoy® 12", Double 6	15.0 sq in (96.774 cm <sup>2</sup> )	perforated	(v-groove)
Envoy® 12", Double 6	7.94 sq in (51.226 cm <sup>2</sup> )	full lanced	(v-groove)
Envoy® 6", Single	7.5 sq in (48.387 cm <sup>2</sup> )	perforated	(v-groove)
Envoy® 12", Double 6	10.6 sq in (68.387 cm <sup>2</sup> )	full lanced	(u-groove)
Envoy® 12", Triple 4	4.4 sq in (28.387 cm <sup>2</sup> )	center lanced	(u-groove)
Envoy® 12", Triple 4	13.2 sq in (85.161 cm <sup>2</sup> )	full lanced	(u-groove)
Envoy® 16", Quad 4	8.9 sq in (57.419 cm <sup>2</sup> )	center lanced	(u-groove)
Endurance® 12", Double 6	15.0 sq in (96.774 cm <sup>2</sup> )	perforated	(v-groove)
Endurance® 12", Double 6	10.6 sq in (68.387 cm <sup>2</sup> )	full lanced	(u-groove)
Endurance® 12", Triple 4	4.4 sq in (28.387 cm <sup>2</sup> )	center lanced	(u-groove)
Endurance® 12", Triple 4	13.2 sq in (85.161 cm <sup>2</sup> )	full lanced	(u-groove)
Economy 12", Triple 4	4.4 sq in (28.387 cm <sup>2</sup> )	center lanced	(u-groove)
Economy 12", Triple 4	13.2 sq in (85.161 cm <sup>2</sup> )	full lanced	(u-groove)

## RELEVANT STANDARDS/CODES

Mastic aluminum siding products meet or exceed the following standards and/or code approvals:

Industry Standards	Building Codes
AAMA	1402.86
FHA	4900.1 for single-family dwellings
FHA	4910.1 for two-family dwellings
DOD	4720.21 for military family housing
ICC Evaluation Service	ER-1478
Metro Dade	07-1026.01
State of Florida	5538
State of Florida	11191
State of Florida	5544-R1
State of Florida	5548
Texas State Board of Insurance Ruling	EC-27

## PROTECTION

Direct contact of aluminum products with certain dissimilar materials, or contact with water run-off from dissimilar materials, is likely to result in corrosion. See warranty and installation instructions for more details.

## WARRANTY

Mastic backs its aluminum siding, aluminum soffit and select aluminum trim coil with a Mastic V.I.P. Limited Lifetime Warranty. Consult warranty certificates for complete coverage details.

## RAIN REMOVAL SYSTEMS

*Mastic rain removal systems are designed for use in residential and light commercial applications.*

## MANUFACTURING PHYSICALS

All Mastic rain removal systems are made of 3105 aluminum sheet (minimum tensile strength 26,000 psi; minimum yield strength 22,000 psi) or equivalent. Mastic Rain Removal Systems are designed to be free-floating, enabling the gutters to expand and contract with temperature changes while minimizing stress points that cause buckling and leaks.

Mastic gutters, when properly installed, will support a minimum of 50 pounds (22.7 kg) per lineal foot. Six different types of free-floating hanger systems are available in the 5" (127) series, and four hanger systems are available in the 6" (152.4) series. These hanger systems permit the gutter to be used in both new construction and all types of remodeling work. Gutter hangers are nominal .051" – .082" (1.3 – 2.1) thickness, depending on the style specified.

All hanger systems provide a concealed attachment at the front of the gutter, eliminating any exposed protrusions that would detract from the appearance of the gutter. Spikes and ferrules (which restrict the movement of the gutter) and brackets attached to the outside periphery of the gutter not recommended.

Two different types of high-quality, corrosion-resistant Rain Removal Systems are available.

## SYSTEM DESCRIPTION

Envoy® 5" is a premium-quality system used in single-family homes and light commercial building applications. Available with a heavier gauge material in both 2" x 3" (51 x 76) and 3" x 4" (76.2 x 101.6) downspout sizes to accommodate most rain removal requirements.

Envoy® 6" works best on large homes where a bigger system will enhance the architecture, or apartments, multi-family complexes and other light commercial buildings. Designed to be a heavy-duty, large-capacity rain removal system, it is available with a 3" x 4" (76 x 102) downspout.

## DIMENSIONS

### Gutters

Envoy® 5": nominal .032 (.813) thickness, 16'0" (4877), 21'0" (6401), 26'0" (7925), 33'0" (10058) and 37'0" (11278) lengths, six hangers

Envoy® 6": nominal .032 (.813) thickness, 21'0" (6401) and 37'0" (11278) lengths, four hangers

### Downspouts

2" x 3" (51 x 76): nominal .024 (.610) thickness, 10'0" (3048)

3" x 4" (76 x 102): nominal .024 (.610) thickness, 10'0" (3048)

2" x 3" (51 x 76): nominal .019 (.483) thickness, 10'0" (3048)

3" x 4" (76 x 102): nominal .019 (.483) thickness, 10'0" (3048)

4" x 5" (102 x 127): nominal .027 (.656) thickness, 10'0" (3048)

4" (102): nominal .024 (.610) thickness, 10'0" (3048)

## ACCESSORIES

All accessories used with Mastic rain removal systems shall be Mastic accessories designed for use with the gutters and will have the same finish. Mill finish accessory components include eave tubes, hangers and expansion joints.

Roof aprons: nominal .027 (.686) thickness

End caps: nominal .024 (.610) thickness both in the Envoy® 5" and the Envoy® 6"

Inside and outside miters: nominal .032 (.813) thickness

Sealant material: Mastic Gutterseal

Expansion joints: aluminum lined with neoprene

Downspout clips: nominal .024 (.356) thickness

NOTE: All measurements noted in ( ) are in millimeters (mm).

## PROTECTION

Direct contact of aluminum products with certain dissimilar materials, or contact with water run-off from dissimilar materials, is likely to result in corrosion. See warranty and installation instructions for more details.

## WARRANTY

Sectional rain removal systems have a Mastic V.I.P. Limited Lifetime Warranty. Consult the actual product warranty for complete coverage details.

## VENTILATION SYSTEMS

*Mastic Vent-A-Systems are designed for use in residential and light commercial applications.*

## MANUFACTURING PHYSICALS

VAR and VAS Mastic Vent-A-System ridges and Vent-A-Strip vents are made of 3105 aluminum sheet (minimum tensile strength 29,000 psi; minimum yield strength 28,000 psi).

VAR and VAS (except mill finish) have an Alumalure® 2000 finish. The finish is a two-coat acrylic applied in a two-phase operation that includes a corrosion-inhibiting primer and a baked-on, high-performance acrylic topcoat. Prior to painting, the metal receives a special cleaning to assure maximum paint adhesion.

## SYSTEM DESCRIPTION

Mastic VAR, installed along the ridge of the building, provides the balance necessary for uniform, continuous airflow when used in conjunction with Vent-A-Strip® or proper soffit venting. Vent-A-Ridge® is designed to afford excellent protection against rain and snow. VAR is available in a low-gloss painted model.

VAS provides the vital balance needed for optimum operation used in conjunction with Mastic VAR, and is designed to reduce harmful condensation and excessive temperature buildup in attic areas.

Mastic Vented Soffit may be used instead of VAS when construction conditions do not permit installation of the lineal product.

Ventilation area (net free area per lineal foot)

VAR 18 square inches (116.13)

VAS (model 70) 8.8 square inches (56.77)

VAS (model 79) 9.9 square inches (63.87)

NOTE: All measurements noted in ( ) are in square centimeters (cm<sup>2</sup>).

## PROTECTION

Direct contact of aluminum products with certain dissimilar materials, or contact with water run-off from dissimilar materials, is likely to result in corrosion. See warranty and installation instructions for more details.

## WARRANTY

Mastic Vent-A-Systems are backed by an exclusive V.I.P. Limited Lifetime Warranty. Consult actual product warranty certificates for complete coverage details.

# Index

OBM6.....	144	CW240.....	18	F1C6SR02425.....	132	HVS10N.....	41
OSM6.....	144	CW240S.....	19	F1C8SR25.....	134	HVS10V.....	41
1WAP10.....	120	CW250.....	18	F1C8SR02425.....	132	IBM5.....	142
2JN2A25.....	121	D4SWG.....	180	F1C10SR25.....	134	IBM5.....	153
3F.....	121	D5DLSWG.....	181	F1C10SR02425.....	132	IBM6.....	144
4APN20.....	135	D5SWG.....	180	F1C425.....	130	IC5220.....	165
4NCR.....	119	D5090.....	119	F1C625.....	130	IC6220.....	168
4NCR024.....	118	D11500.....	163	F1C825.....	130	INTAKE.....	76
5N090024.....	118	D11600.....	166	F1C1025.....	130	INTVENT.....	77
6N225.....	120	DC10500.....	141	F1C4025.....	131	ISBAY5.....	143
6N225NCR.....	120	DC13750.....	141	F1C6025.....	131	ISBAY6.....	145
8NA.....	118	DC1375500.....	141	F1C8025.....	131	ISM5.....	142
8NA019.....	119	DENTILSTP.....	63	F1C10025.....	131	ISM5.....	153
8SWG.....	180	DPB.....	152	F4SWG.....	186	ISM6.....	144
34JS.....	184	DPB.....	153	F6SWG.....	186	ISM7.....	154
58ALJ25.....	136	DRYERHOOD.....	75	F8S25.....	137	JMBLOCK.....	68
78ALJ25.....	136	DRYERHOOD6.....	75	F8SWG.....	186	JMBLOCKSC.....	68
78SJ.....	183	DS2X3.....	148	F10SWG.....	186	JMEBLOCK.....	69
125JS.....	184	DS2X38.....	149	F12.....	137	JMEBLOCKSC.....	69
AIRVENT.....	75	DS3X4.....	150	F438.....	135	JMEBLOCK.....	69
AM5HID.....	147	DS3X4.....	153	F438425.....	135	JMEBLOCKSC.....	69
AM5ZIP500.....	147	DS3X48.....	151	FC4SR.....	133	JSCMNT126.....	7
AM6ZIP.....	147	DS4X5.....	154	FC6SR.....	133	JSCMNT126.....	39
AM7HID 01.....	154	DSR4.....	155	FC8SR.....	133	JSCMNT126.....	49
AM7ZIP 01.....	154	DTWINMTL36 - 44.....	65	FC10SR.....	133	KEYSTN.....	63
APSN52.....	164	E2X3A.....	148	FD1060H - 2028S.....	172	KEYSTONE.....	65
APSN62.....	167	E2X3A30.....	149	FE5.....	146	LCAS12313.....	128
ARCH15LV.....	59	E2X3B.....	148	FE6.....	146	LCAS12316.....	127
ARCH15RP.....	54	E3X4A.....	150	FFOP55.....	35	LCAS12316.....	153
ASDIV.....	147	E3X4A.....	153	FF57 - 88S.....	176	LCAS12319.....	124
ASVSS25.....	32	E3X4A30.....	151	FVENT.....	78	LCAS16419A.....	125
ASVSS35.....	32	E3X4B.....	150	GA2029H.....	174	LD55T.....	22
AWOP06.....	33	E3X4B.....	153	GA2029S.....	174	LEDGE152X3.....	150
BASE2P0625 00.....	182	E4X5A.....	154	GC11750.....	140	LEDGE203X4.....	151
BASE2P1125 00.....	183	E4X5B.....	154	GC11875.....	140	LEDGE302X3.....	150
BASECAP.....	61	EBLOCK.....	71	GC15000.....	140	LEDGE403X4.....	151
BAYOP06.....	34	EC5L.....	143	GC17875.....	154	LEDGE603X4.....	151
BB10SWG.....	181	EC5R.....	143	GC1175032.....	140	LFAS12216.....	126
BB70.....	25	EC6L.....	145	GC1175032.....	153	LFAS12219.....	123
BBARCH41 - 85.....	57	EC6L.....	153	GC1187532.....	140	LFAS12313.....	128
BRKENDCAP.....	64	EC6R.....	145	GC1187532.....	153	LFAS12316.....	127
CAPSWG.....	182	EC6R.....	153	GC1300032.....	140	LFAS12316.....	153
CB65.....	24	EC7L.....	154	GC1500032.....	140	LFAS12319.....	124
CD50P2.....	4	EC7R.....	154	GC1500032.....	153	LFAS16413.....	129
CD65HR.....	4	EC24.....	117	GCTU.....	152	LIN5.....	36
CD70P2.....	4	EC24T.....	117	GCTU.....	153	LIN35.....	36
CD95HS.....	5	EC40.....	31	GCTU1.....	152	LINF5.....	36
CD700CP2.....	5	EC50.....	31	GCTU1.....	153	LINQRS.....	12
CD1028H - 2028S.....	173	ECD45.....	31	GR1.....	152	LINQRS.....	35
CDHSOCP.....	6	ENDCAP.....	65	GRT6SR12.....	134	LL510.....	170
CDMFT.....	6	ESR4.....	155	GS50Z.....	147	LL610.....	170
CDP500CP.....	5	EXVENT.....	76	GS4040XH.....	175	LS54.....	170
CDSS.....	4	EXVENT6.....	77	GSW40Z J1.....	147	LS64.....	170
CLV1530.....	58	EZBLK040.....	74	GT2125.....	135	MANTEL.....	61
COLOR MATRIX.....	84-100	EZBLK070.....	73	GZS8.....	152	MANTEL120.....	63
CPSSHD.....	6	EZBLK080.....	73	HR5400.....	165	MANTELOVLY.....	61
CRP1530.....	58	EZBLK110.....	74	HR6400.....	168	MBLOCK.....	66
CW2D45.....	18	F1C4SR25.....	134	HRC5400.....	165	MBLOCKR.....	67
CW80S.....	19	F1C4SR02425.....	132	HRC6400.....	168	MC30.....	29
CW230S.....	19	F1C6SR25.....	134	HRDGV.....	80	MC40.....	28

# Index

MC50.....	29	OV30S.....	27	S24W.....	107	SRD41EPS.....	10
MCD40.....	28	OV40.....	26	S24150.....	106	SRD61EPS.....	9
MCD45.....	28	OV50.....	26	SAS12216.....	126	SRD61EPSLS.....	11
MCD50.....	29	OV65.....	27	SAS12219.....	123	SRD451EPS.....	10
METER.....	70	OVD45.....	26	SAS12313.....	128	SRD451EPSLS.....	11
METERLG.....	70	PBF237 – 448S.....	177	SAS12316.....	127	SRICP125.....	13
MFCH04.....	48	PBS80N.....	42	SAS12316.....	153	SRJSCMNT126.....	12
MFT.....	40	PBS80V.....	42	SAS12319.....	124	SRL24.....	109
MICP06.....	34	PBSJ03.....	42	SAS16413.....	129	SRL24T.....	109
MTOP06.....	34	PEDIMENTST.....	61	SAS16419A.....	125	SRLIN5.....	12
MVDFT.....	40	PILASTER96.....	62	SAT38.....	136	SRLIN35.....	12
MVFJ061.....	14	PILASTER144.....	62	SC9X150.....	169	SRS71EPS.....	9
MVFJ0341.....	38	PLWINMTL36 – 44.....	65	SC10625.....	185	SRS71EPSLS.....	11
MVJ04.....	48	PSS10N.....	43	SC13250.....	185	SRSC10625.....	185
MVJ051.....	37	PSS10V.....	43	SCMNT126.....	7	SRSC13250.....	185
MVJ051.....	48	PTS10N.....	45	SCMNT126.....	39	SRSS.....	13
MVJ071.....	37	PTS10V.....	45	SCMNT126.....	49	SSTU.....	184
MVJ125.....	13	PTS12CV.....	44	SCR24.....	110	STC2175.....	185
MVJ125.....	38	PTS12N.....	44	SCR24T.....	110	SVG6N.....	122
MVS250.....	32	PTS12V.....	44	SCROWN126.....	7	SVG6V.....	122
MVSR110.....	32	QD2410H12.....	175	SCROWN126.....	12	SVG12N20.....	122
MVTC05.....	49	QT40.....	15	SCROWN126.....	39	SVG12V20.....	122
OBM5.....	142	QT40LS.....	16	SCROWN126.....	49	SVG420144.....	126
OBM5.....	153	QT40LS255.....	17	SD1515H.....	174	SVG420144.....	126
OC5220.....	165	QT50.....	15	SD2025H.....	174	SVY24.....	116
OC6220.....	168	QTD45.....	15	SD2025S.....	174	SVY24T.....	116
OCPSSM.....	182	QTD45LS.....	16	SDGENDCAP.....	63	TD1029L – 2029H.....	171
OCPSWG.....	182	QTD45LS255.....	17	SF58.....	137	TFOP55.....	35
OCTGV.....	80	ROT2X3.....	146	SF1625.....	137	TN1250.....	138
OCTGV18.....	80	ROT2X3.....	162	SHL24.....	111	TOPCAP.....	61
OG12R1.....	158	ROT3X4.....	146	SHL24T.....	111	TP53ZIP.....	164
OG12R61.....	160	RDGV.....	79	SHOOK.....	60	TP63ZIP.....	167
OG16A.....	156	RDGV18.....	79	SHTCLP12.....	60	TP5100Q.....	164
OG21A.....	156	RDGV36.....	79	SHUTPAINT.....	59	TP5300.....	164
OG21A6.....	159	RDTOPGV14.....	81	SHUTRPLUG.....	60	TP6300.....	167
OG25.....	157	RDTOPGV24.....	81	SJ1625.....	136	TPC5100.....	164
OG26.....	156	RECTGV.....	82	SJH24.....	112	TPC6100.....	167
OG33A.....	156	RECTGV1824.....	83	SJH24T.....	112	TRANRP15.....	54
OG37A.....	156	RECTGV2430.....	83	SKP24.....	113	TRMS10N.....	47
OG37A6.....	159	RF2450 – 425S.....	179	SKP24T.....	113	TRMS10V.....	47
OG91.....	157	RT2.....	162	SMN24.....	114	TS14.....	104
OG101.....	157	RT24F.....	161	SMN24C.....	114	TS24.....	101
OG111.....	157	RT34.....	161	SMN24T.....	114	TS24T.....	101
OG131.....	158	RT235.....	162	SN5200.....	163	TS24TX.....	103
OG141.....	158	RT241.....	161	SN5200BG.....	163	TS24024.....	103
OG155.....	157	RT312.....	158	SN6200.....	166	TS24024T.....	103
OG256.....	160	RT412.....	158	SN6200BG.....	166	TS24150.....	103
OG1061.....	160	RTA2.....	162	SN7200S 00.....	154	UA5200BG.....	165
OG1161.....	160	RTA3.....	161	SN7200S 00.....	169	UA6200BG.....	167
OG1361.....	160	RTA4.....	162	SNX24.....	115	UA11500.....	163
OG1565.....	159	RTA7.....	162	SNX24T.....	115	UA11600.....	166
OSBAY5.....	143	RTA74.....	161	SP7.....	146	UNIBLOCK.....	66
OSBAY6.....	145	RTB7.....	162	SP8.....	146	UNIBLOCKKSC.....	67
OSM5.....	142	RTB74.....	161	SQ6X038.....	169	UNIBLOCKXL.....	68
OSM6.....	153	S1WAP.....	182	SQGV1414.....	82	UTS.....	183
OSM7.....	154	S14.....	107	SROCP4.....	13	UVS12CP.....	46
OSR420.....	155	S24.....	106	SR1175032.....	140	UVS12N.....	46
OSR440.....	155	S24LM.....	106	SR1300032.....	140	UVS12P.....	46
OSR460.....	155	S24T.....	106	SR1500032.....	140	VAR.....	139
OT4X5 01.....	154	S24T150.....	106	SR11875032.....	140	VAREP36.....	139

# Index

---

VAS70.....	139
VAS79.....	139
VFR05.....	48
VIN3C1131 – 1181.....	53
VIN4C1531 – 1581.....	56
VIN301231 – 1281.....	53
VIN401631 – 1681.....	56
VINITT.....	60
VINLV1255 – 1259.....	52
VINLV1525 – 1581.....	55
VINRP1227 – 1271.....	51
VINRP1531 – 1581.....	54
VSS10NS.....	32
VSS10NS.....	120
WBTU.....	138
WC24.....	105
WC24T.....	105
WCNCSS.....	36
WCRSS.....	36
WCT06.....	40
WCT12.....	13
WCT12.....	40
WE0SC4.....	23
WE40.....	23
WED40.....	23
WGV40.....	20
WGV50.....	20
WGV80.....	21
WOC306.....	33
WV18H – 24HRS.....	178

---

Notes:



**HOVER transforms smartphone photos of any home to a fully measured, customizable 3D model so you can estimate a project confidently and easily visualize what the final project will look like.**

## HOW HOVER WORKS:



### SNAP A FEW PHOTOS

Photos are captured using the HOVER app and are automatically uploaded to the cloud. Take a minimum of 8 photos capturing every angle of the home and that's it for you.



### PATENTED TECHNOLOGY

Once the photos are uploaded, HOVER's patented technology transforms them into a fully measured and customizable 3D model. We notify you when your deliverables are ready.



### REVIEW MEASUREMENTS

Access all measurements on the interactive 3D model in the mobile app or online. You can also export all all measurements to a PDF or Excel file.



### CUSTOMIZE ANY HOME

On the interactive 3D model you can use the design features to change the roof, siding, windows and more. You can also share a link to this 3D model to make sure everyone is on the same page.

## HOW TO DOWNLOAD HOVER AND SIGN UP:

Just follow the steps to download the app and create an account

1. Open the app store on your mobile device
2. Search for HOVER 3D
3. Download the HOVER app
4. Once downloaded on your mobile device, open the HOVER app
5. Tap "New User Sign Up." Enter your email address and click on "Professional"
6. Enter your contact info and set a password



The **only** siding with bold colors backed by our No Fade, No Distortion Promise.



Ply Gem Mastic SolarDefense Reflective Technology™ is an innovative, industry-leading breakthrough in siding that offers protection and resistance to heat distortion for unprecedented durability. Now you can confidently offer your clients darker, on-trend colors from the leader in vinyl siding, backed by the industry's only **No Fade, No Distortion Promise**. It offers peace of mind that – like our colors – won't fade.

**Top layer** disperses heat and helps resist fading by allowing light energy to flow both ways.

**Cooling compound** scatters light, reflecting heat away, keeping panels cooler.

**Base layer** stands up to heat, preventing distortion.

Warranted against (i) fade in excess of a Delta E of 1 Hunter unit and (ii) heat distortion from normal climate conditions or normal reflective light sources. See product warranty for details and terms and conditions.

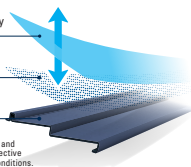

mastic.com  
800 962 6973

PLY GEM SIDING GROUP  
2600 GRAND BLVD. SUITE 900  
KANSAS CITY, MO 64108



PLY GEM RESERVES THE RIGHT TO ALTER, MODIFY OR DELETE ITEMS FROM TIME TO TIME WITHOUT NOTICE. CONTACT YOUR DISTRIBUTOR OR SALES REPRESENTATIVE FOR ACTUAL PRODUCT AND COLOR SAMPLES. MASTIC, THE MASTIC LOGO AND PLY GEM ARE TRADEMARKS OF PLY GEM INDUSTRIES, INC. AND/OR ITS SUBSIDIARIES. © 2019 MASTIC®, PART OF THE **CORNERSTONE BUILDING BRANDS** FAMILY. ALL RIGHTS RESERVED.

All products made in the U.S.A.

7601099991112/RevF/MS/CG/1219